

lifestyle home inspirations

life style

home inspirations



TONIN CASA s.r.l.
Via Palladio, 43
S. Giorgio in Bosco
35010 PADOVA
Tel. +39 049 945 3300
Fax +39 049 945 0725
info@tonincasa.it
www.tonincasa.it



life style

home inspirations

Un gusto e una personalità che raccontano uno stile di vita che si concretizza in prodotti originali, dalle forme fluide ed espressive, lontano dalle solite fredde ed anonime geometrie.

Un rinnovato equilibrio fra natura e tecnologia che diventa naturale espressione di eleganza e buon gusto in uno spazio vero e vitale, in cui sentirsi bene, capace di donare energia positiva e far riscoprire antichi valori mai passati di moda.

Ispirata a questi ideali è nata "Life Style" la nuova collezione di Tonin Casa per vivere con stile la vita di tutti i giorni_

Taste and personality of a life style which is represented by original products with flowing shapes, far from the anonymous and cold geometrical ones. A refreshing balance between nature and technology which becomes the elegant expression of a space where you can feel good, a space able to give a positive energy and allows to rediscover ancient values.

This is how "Life style" was born, Tonin Casa's new collection for a stylish every day life_



vero stile italiano_

ALL THE ITALIAN QUALITY

TONIN CASA prosegue nella realizzazione di prodotti che si contraddistinguono per l'alto valore tecnologico e qualitativo, nonché frutto di una grande ricerca stilistica. Al valore intrinseco di tutta la collezione si aggiunge la scelta di brevettare tutti gli articoli della Tonin Casa, sinonimo soprattutto del vero Made in Italy. La scelta di utilizzare una vasta gamma di materiali pregiati che comportano lavorazioni molto complesse e diverse tra di loro, sottolinea la volontà di produrre un arredo pensato e realizzato ora, ma destinato a durare nel tempo. Dalla pressofusione d'alluminio, allo stampato rotazionale, passando attraverso la manifattura artigianale necessaria per la realizzazione degli imbottiti, fino alle ante in poliuretano realizzate con la tecnica dello stampaggio tridimensionale, tutto il processo creativo e produttivo si fonda sulla volontà di produrre con la massima qualità, oggetti che devono essere poi sintesi di design funzionale, un design che, anche attraverso l'utilizzo di materiali riciclabili, rispetti l'ambiente e l'uomo che vi abita_

TONIN CASA continues in its designing of products which distinguish themselves for their high technological and qualitative value, the result of meticulous stylistic research. To the intrinsic value of the whole collection is added the decision to patent all the articles so as to safeguard the customer who has chosen to purchase a product Tonin Casa, synonymous above all of real Made in Italy. The choice to use a vast range of precious materials which require very complex and varied workmanship, underlines the will to produce furnishings thought and manufactured today but destined to last in time. From melt aluminium, to rotational moulding, passing through the artisanal manufacturing necessary for creation of upholstery, to the doors in polyurethane made with the technique of three dimensional moulding, all the creative production process is founded on the will to produce with maximum quality objects which must be a synthesis of functional design, a design which, even through the use of recyclable materials, respect nature and environment_

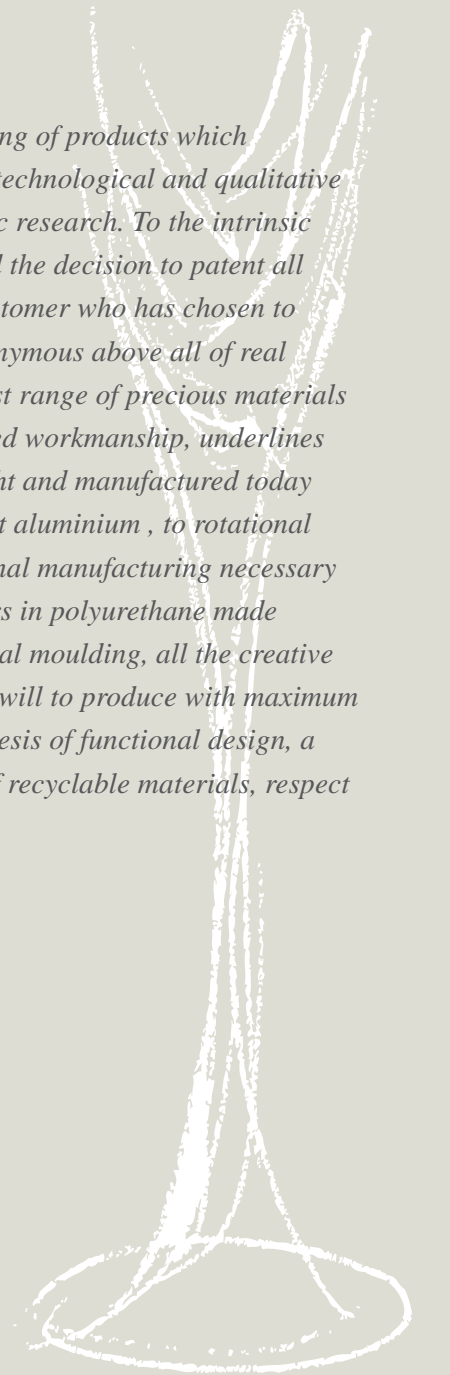
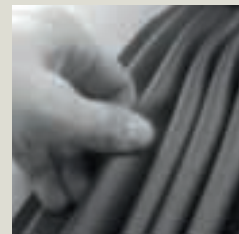

DINING

tavoli fissi
_fixed tables

brenta	12
bridge	32
eliseo/big eliseo	50
ghost	56
la defense	60
tokyo	38
wave	26

tavoli allungabili
_extendible tables

bonton	64
brenta	12
bridge	32
light	42
shanghai	20
smart	62
wave	26

tavoli allungabili da cucina
_kitchen extendible tables

bonton	64
light	42
smart	62

sedute
_seats

aria easy	88
calice	98
cover	86
hole	92
lisetta	72
mary	96
regina	76
round	82
simply	68
soft	84
sorbona	80

STORAGE UNITS

contenitori
_storage units

bands	108
goya	118
leaves living	126
leaves	120
onda	102
pois	112

LIVING

divani e poltrone
_sofas and armchairs

blum	146
duny	142
nolita	164
playa buena	152
ricciolo	158

tavolini e pouf
_coffee tables and pouf

beside	180
gomitolo	196
ios	186
kos	182
plissé	192
quiet	168
splash	176
velo	178
volup	172

ACCESSORIES

accessori e complementi
_accessories and
occasional furniture

alga	206
callas	220
ivy	210
narciso	214
spiga	200
stone	218
vanilla	212

NIGHT

letti
_beds

cloud	234
île	252
pacifico	246
sleepy	224
tuny	230

contenitori notte
_night storage units

leaves night	242
teeny	240
venice night	250

tavoli fissi
_fixed tables



brenta pag. 12



ghost pag. 56



wave pag. 26



la defense pag. 60



bridge pag. 32



tokyo pag. 38



eliseo e big eliseo pag. 50

tavoli allungabili da cucina
_kitchen extendible tables



light pag. 42

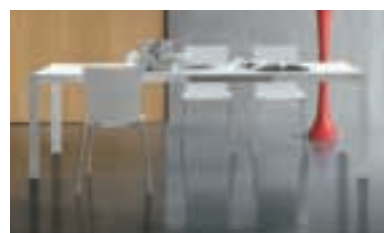

smart pag. 62



bonton pag. 64

tavoli allungabili
_extendible tables



brenta pag. 12



shanghai pag. 20

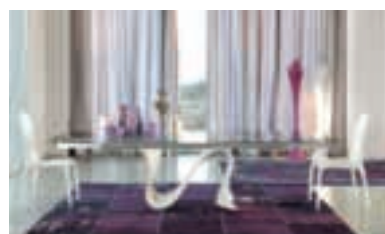

wave pag. 26



bridge pag. 32

sedute
_seats

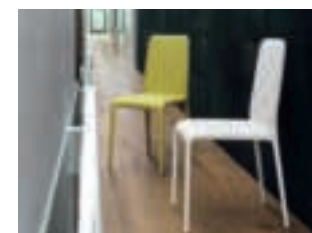

soft pag. 84

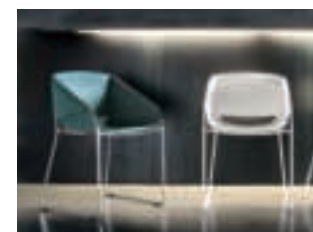

simply pag. 68

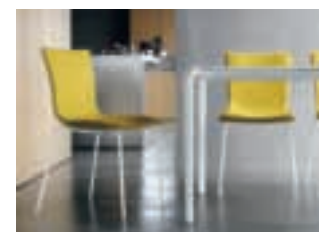

cover pag. 86



lisetta pag. 72

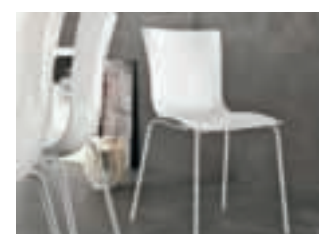

aria easy pag. 88

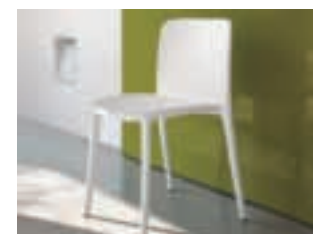

regina pag. 76

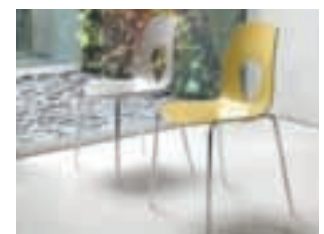

hole pag. 92



sorbona pag. 80



mary pag. 96



round pag. 82



calice pag. 98

contenitori
_storage units



onda pag. 102



bands pag. 108

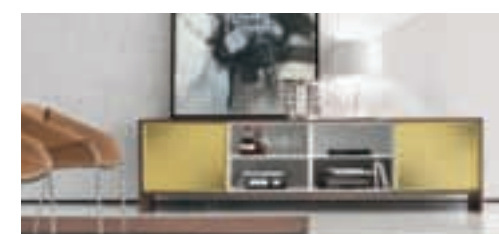

pois pag. 112



goya pag. 118



leaves pag. 120

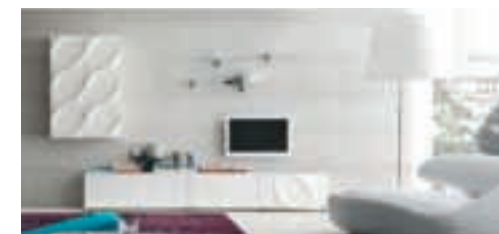

leaves living pag. 126

**divani e poltrone
_sofas and armchairs**



duny pag. 142



blum pag. 146



playa buena pag. 152



ricciolo pag. 158



nolita pag. 164

**tavolini e pouf
_coffee tables
and pouf**



beside pag. 180



kos pag. 182



quiet pag. 168



ios pag. 186



volup pag. 172



plissé pag. 192

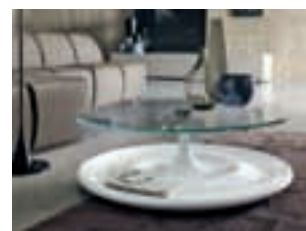

splash pag. 176



gomitolo pag. 196



velo pag. 178

**accessori e complementi
_accessories and
occasional furniture**

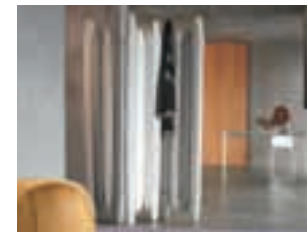

vanilla pag. 212



narciso pag. 214



stone pag. 218



spiga pag. 200



callas pag. 220



alga pag. 206

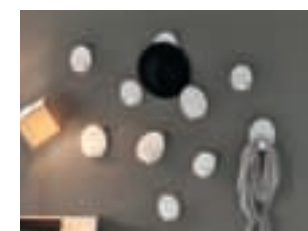

ivy pag. 210

**letti e contenitori
_beds and
night storage units**



sleepy pag. 224



tuny pag. 230



cloud pag. 234

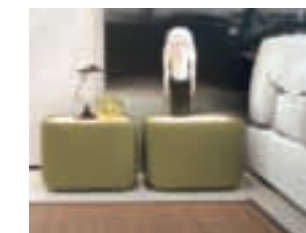

teeny pag. 240



pacifico pag. 246



leaves night pag. 242



île pag. 252



venice night pag. 250

tavoli_tables

brenta
shanghai
wave
bridge
tokyo
light
eliseo
ghost
la defense
smart
bonton

brenta

design_Angelo Tomaiuolo

BRENTA_ART. 8057 LP/LA/LG/LZ/P/A/G/Z

Combinazione di tavoli fissi ed allungabili con base in metallo curvato e laccato. Disponibili in diverse dimensioni e con piani in MDF impiallacciato rovere taglio sega, noce canaletto, laccato bianco o vetro temperato. Brenta è nato per soddisfare le esigenze più svariate con grande gusto e mondanità_

Combination of fixed and extendible tables with bases in curved lacquered metal. Available in many dimensions and with the top in MDF veneered saw cut oak, black walnut, white laquered or tempered glass. Brenta was designed to satisfy the most diverse needs with good taste and worldliness_

Misure_Sizes

Tavolo con piano in legno fisso_Table with fixed wooden top

LP L 140 P 140 H 75

LA L 200 P 100 H 75

LG L 250 P 120 H 75

LZ L 300 P 120 H 75

Tavolo con piano in vetro allungabile_ Table with extended glass top

P L 160/240 P 90 H 75

A L 180/260 P 90 H 75

G L 200/300 P 100 H 75

Z L 200/300 P 100 H 75







Brenta il tavolo progettato per arredare ambienti differenti. In questa pagina nella versione quadrata 140x140 cm con base in metallo curvato e laccato con piano in MDF impiallacciato noce canaletto.

Brenta is manufactured in order to furnish diverse kind of ambients. In this page it is in the square version 140x140 cm with a base in curved and laquered metal and with top in black walnut veneered MDF.



BRENTA

informazioni tecniche
technical sheets

TAVOLI FISSI
FIXED TABLES

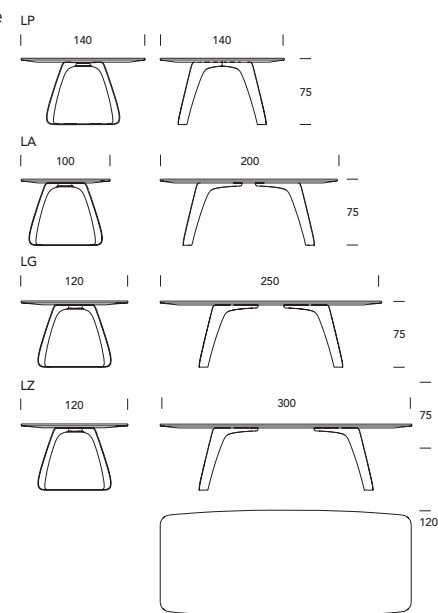

TAVOLI ALLUNGABILI
EXTENDIBLE TABLES

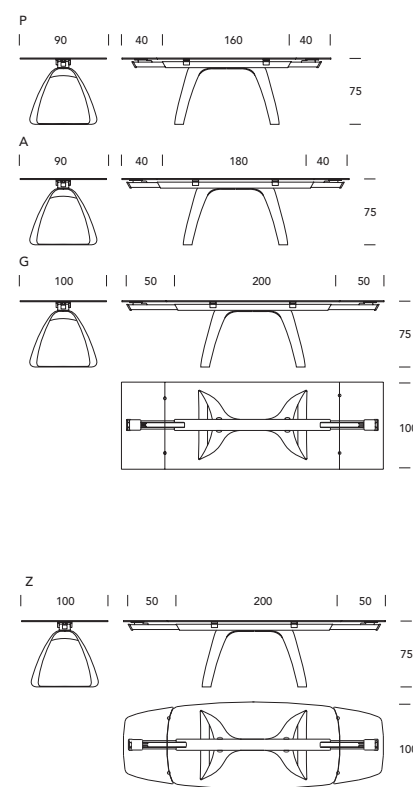

FINITURE BASE
ALLUNGABILE
EXTENDIBLE
STRUCTURE FINISHING



FINITURE
BASE FISSA
FIXED STRUCTURE
FINISHING



FINITURE
PIANI LEGNO
WOODEN TOP
FINISHING

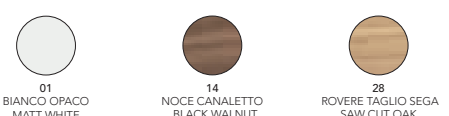

FINITURE PIANI
IN VETRO DI SERIE
GLASS TOP
STANDARD FINISHING



FINITURE BINARIO
ALLUNGABILE
GUIDE BAR FINISHING
EXTENDIBLE

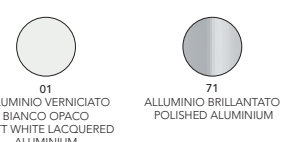

shanghai

design_Angelo Tomaiuolo

SHANGHAI_art. 8062 P/A/G/Z

Tavolo allungabile con binario centrale interamente in alluminio, piano e allunghe in vetro temperato. Basamento in agglomerato dalle forme scultoree ideale per chi cerca un design raffinato e senza tempo_

Extendible table with central guide bar in aluminium, top and extensions in tempered glass. Agglomerate base of sculptural form, ideal for those looking for refined and timeless design_

Misure_Sizes

P L 160/240 P 90 H 75

A L 180/260 P 90 H 75

G L 200/300 P 100 H 75

Z L 200/300 P 100 H 75







SHANGHAI
informazioni tecniche
technical sheets

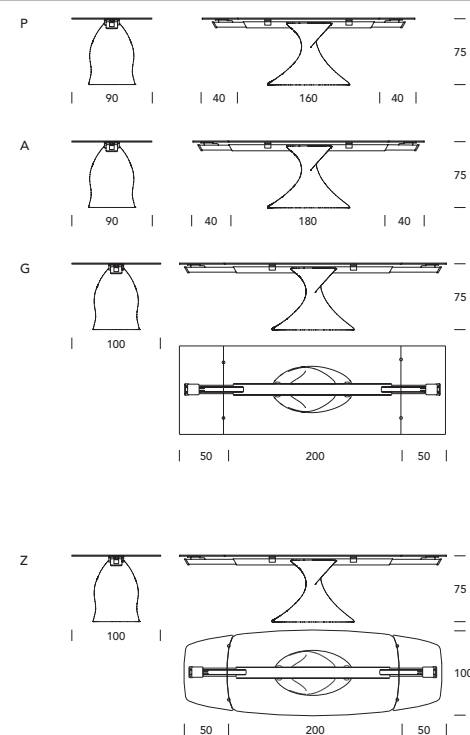

FINITURE BASE STRUCTURE FINISHING	01 BIANCO OPACO MATT WHITE	501 BIANCO LUCIDO SHINING WHITE	S36 BEIGÉ LUCIDO SHINING BEIGE	S64 ANTRACITE LUCIDO SHINING ANTHRACITE
FINITURE BINARIO GUIDE BAR FINISHING	01 ALLUMINIO VERNICIATO BIANCO OPACO MATT WHITE LACQUERED ALUMINIUM	71 ALLUMINIO BRILLANTATO POLISHED ALUMINIUM		
FINITURE PIANI IN VETRO GLASS TOP FINISHING	V81 TRASPARENTE TRANSPARENT	V100 EXTRA WHITE TRASPARENTE EXTRA CLEAR TRANSPARENT	V101 EXTRA WHITE BIANCO EXTRA CLEAR WHITE	
FINITURE PIANI IN VETRO SU ORDINAZIONE SOLO PER VERSIONE PIANO RETTANGOLARE GLASS TOP CUSTOMIZED FINISHING FOR RECTANGULAR TOP ONLY	V136 EXTRA WHITE BEIGE EXTRA CLEAR BEIGE			



wave

design_Studio 28

WAVE_ART. 8014 P/A/G/D/FP/FA/FG/FD/ER

Tavolo fisso o allungabile con binario in alluminio, piano e allunghe in vetro temperato. Basamento stampato in Baydur®, materiale di ultima generazione che riunisce libertà creativa e funzionalità. Wave arreda la tua casa all'insegna del design più estremo_

Fixed or extendible table with aluminium guide bar, top and extensions in tempered glass. Moulded base in Baydur®, a new generation material which combines liberty, creativity and functionality. Wave furnishes your home in the light of extreme design_

Misure_Sizes

Allungabile/Extendible

P L160/240 P 90 H 75

A L 180/260 P 90 H 75

G L 200/300 P 100 H 75

D L 200/300 P 110 H 75

Fisso/Fixed

FP L 160 P 90 H 75

FA L 180 P 90 H 75

FG L 200 P 100 H 75

FD L 200 P 110 H 75

Fisso ellittico/Elliptic fixed

ER L 220 P 110 H 75





WAVE
informazioni tecniche
technical sheets

TAVOLI FISSI FIXED TABLES		TAVOLI ALLUNGABILI EXTENDIBLE TABLES		FINITURE BASE STRUCTURE FINISHING			
FP 90 160		P 90 160 40			01 BIANCO OPACO MATT WHITE		501 BIANCO LUCIDO SHINING WHITE
FA 90 180		A 90 40 180 40			502 NERO LUCIDO SHINING BLACK		532 ALLUMINO LUCIDO SHINING ALUMINIUM
FG 100 200		G 100 50 200 50			536 BEIGE LUCIDO SHINING BEIGE	FINITURE BASE SU ORDINAZIONE STRUCTURE CUSTOMIZED FINISHING	
FD 110 200		D 110 50 200 50			551 FANGO LUCIDO SHINING MUD		RAL RAL A RICHIESTA RAL ON REQUEST
ER 110 220				FINITURE BINARIO ALLUNGABILE GUIDE BAR FINISHING EXTENDIBLE			
					01 ALLUMINIO VERNICIATO BIANCO OPACO MATT WHITE LACQUERED ALUMINIUM		32 ALLUMINIO ANODIZZATO ANODIZED ALUMINIUM
					71 ALLUMINIO BRILLANTATO POLISHED ALUMINIUM	FINITURE PIANI IN VETRO RETTANGOLARE DI SERIE RECTANGULAR GLASS TOP STANDARD FINISHING	
					V2 NERO BLACK		V81 TRASPARENTE TRANSPARENT
					V100 EXTRA WHITE TRASPARENTE EXTRA CLEAR TRANSPARENT		V101 EXTRA WHITE BIANCO EXTRA CLEAR WHITE
				FINITURE PIANI IN VETRO ELLITTICO DI SERIE ELLIPTICAL GLASS TOP STANDARD FINISHING			
					V81 TRASPARENTE TRANSPARENT	FINITURE PIANI IN VETRO SU ORDINAZIONE SOLO PER VERSIONE PIANO RETTANGOLARE GLASS TOP CUSTOMIZED FINISHING FOR RECTANGULAR TOP ONLY	
					V136 EXTRA WHITE BEIGE EXTRA CLEAR BEIGE		V601 EXTRA WHITE ACIDATO BIANCO EXTRA CLEAR ETCHED WHITE



bridge

Design_Angelo Tomaiuolo

BRIDGE_ART. 8063 P/A/G/D/FP/FA/FG/FD

Tavolo allungabile con binario in alluminio, piano e allunghe in vetro temperato. Gambe a ponte realizzate con tecnologia ad iniezione di poliuretano per dare vita a forme più morbide, sinonimo di semplicità ed eleganza. Disponibile anche nella versione fissa_

Extendible table with aluminium guide bars, top and extensions in tempered glass. The legs with the bridge shape are made with polyurethane injection technology in order to give a softer form, synonymous of simplicity and elegance. The fixed version is also available_

Misure_Sizes

Allungabile/Extendible

P L 160/240 P 90 H 75

A L 180/260 P 90 H 75

G L 200/300 P 100 H 75

D L 200/300 P 110 H 75

Fisso/Fixed

FP L 160 P 90 H 75

FA L 180 P 90 H 75

FGL 200 P 100 H 75

FDL 200 P 110 H 75



bridge design_Angelo Tomaiuolo

*Il suo nome rivela la sua vocazione,
Bridge un ponte che unisce i
numerosi commensali che grazie
alle tecnologiche prolunghe possono
trovare posto a tavola_*

*Its name reveals its vocation,
Bridge is a flyover that brings people
together at the table everyone can
easily find a place thanks to the
technological extensions_*





BRIDGE
informazioni tecniche
technical sheets

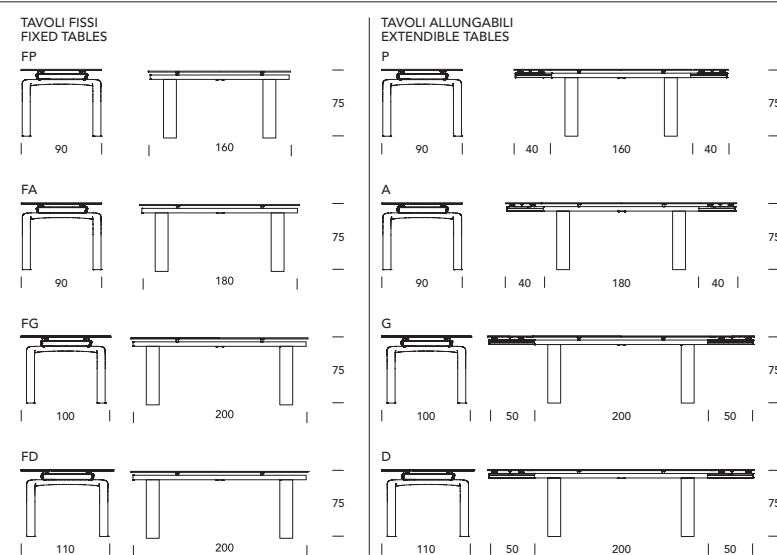

FINITURE BASE
STRUCTURE FINISHING

01 BIANCO OPACO MATT WHITE	S01 BIANCO LUCIDO SHINING WHITE

FINITURE BINARIO
GUIDE BAR FINISHING

01 ALLUMINIO VERNICIATO BIANCO OPACO MATT WHITE LACQUERED ALUMINIUM	32 ALLUMINIO ANODIZZATO ANODIZED ALUMINIUM	71 ALLUMINIO BRILLANTATO POLISHED ALUMINIUM

FINITURE PIANI
IN VETRO DI SERIE
GLASS TOP
STANDARD FINISHING

V2 NERO BLACK	V81 TRASPARENTE TRANSPARENT
V100 EXTRA WHITE TRASPARENTE EXTRA CLEAR TRANSPARENT	V101 EXTRA WHITE BIANCO EXTRA CLEAR WHITE

FINITURE PIANI IN VETRO
SU ORDINAZIONE
GLASS TOP
CUSTOMIZED FINISHING

V136 EXTRA WHITE BEIGE EXTRA CLEAR BEIGE	V601 EXTRA WHITE ACIDATO BIANCO EXTRA CLEAR ETCHED WHITE



tokyo

design_studio 28

TOKYO (piano legno)_ART. 6951 LA/LG/LZ

*Tavolo fisso con basamento in agglomerato di marmo e piano in MDF
impiallacciato rovere taglio sega, noce canaletto o laccato bianco opaco.
Tokyo è ideale per chi ama la materia viva; il tocco del legno rende
questo originale tavolo tutto da vivere_*

*Fixed table with base in agglomerate marble and top in veneered MDF,
saw cut oak, black walnut or matt white laquered. Tokyo is ideal for those
who love live materials; the feel of wood makes this original table a
pleasure to live with_*

Misure_Sizes

LA L 200 P 100 H 75

LG L 250 P 120 H 75

LZ L 300 P 120 H 75





TOKYO
informazioni tecniche
technical sheets

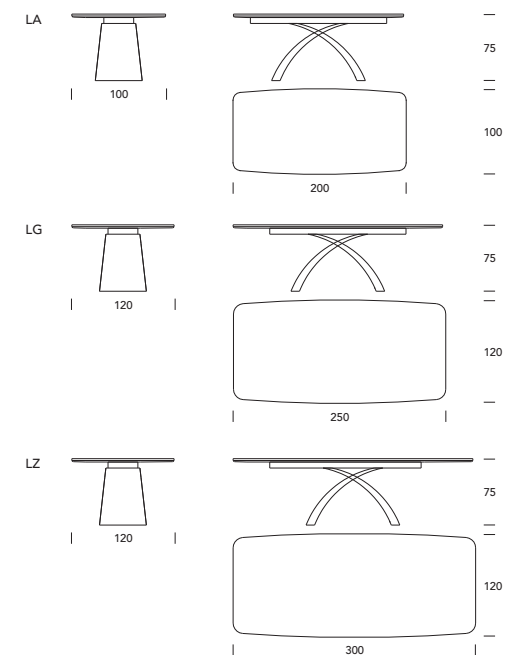

FINITURE BASE STRUCTURE FINISHING	01 BIANCO OPACO MATT WHITE	501 BIANCO LUCIDO SHINING WHITE	502 NERO LUCIDO SHINING BLACK
	536 BEIGE LUCIDO SHINING BEIGE	555 TESTA DI MORO LUCIDO SHINING DARK BROWN	
FINITURE PIANI TOP FINISHING	01 BIANCO OPACO MATT WHITE	14 NOCE CANALETTO BLACK WALNUT	28 ROVERE TAGLIO SEGA SAW CUT OAK

light

design_Studio Archirivolto

LIGHT_ART. 8065 P/A/G

Combinazione di tavoli allungabili con allunghe laterali. Struttura realizzata in fusione di alluminio e disponibile in diverse colorazioni. Piano in cristallo satinato, polimerico o HPL laminato. Light è tecnologia e leggerezza per un carattere deciso, adatto per chi ama la perfezione minimale_

Combination of extendible tables with lateral extensions. Structure made in aluminium fusion and available in different colours. Top in satinated glass, polymeric or HPL laminate. Light is technology and lightness for a decisive character, suitable for those who appreciate minimalistic perfection_

Misure_Sizes

P L 140/185 P 90 H 75

A L 160/205/250 P 90 H 75

G L 180/225/270 P 90 H 75







*Linee morbide e sinuose,
il tavolo Light all'occorrenza
si allunga mantenendo inalterata
la sua linea pulita_*

*Sinuous and soft lines when it is
necessary the table "Light" can be
extended keeping its flawless line
unchanged_*





LIGHT
informazioni tecniche
technical sheets

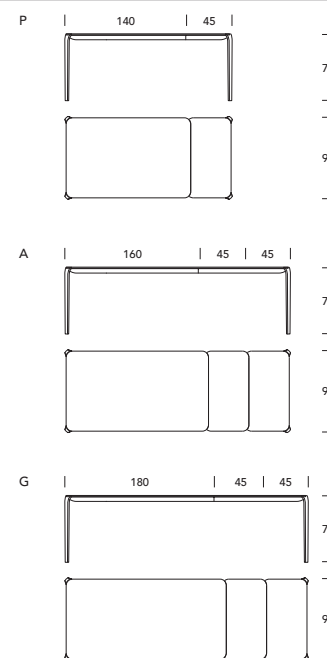

FINITURE STRUTTURA
STRUCTURE FINISHING

01 ALLUMINIO VERNICIATO BIANCO OPACO MATT WHITE LACQUERED ALUMINIUM	36 ALLUMINIO VERNICIATO BEIGE OPACO MATT BEIGE LACQUERED ALUMINIUM	64 ALLUMINIO VERNICIATO ANTRACITE OPACO MATT ANTHRACITE LACQUERED ALUMINIUM

FINITURE PIANO E ALLUNGHE IN POLIMERICO LAMINATO
LAMINATED POLYMERIC TOP AND EXTENSIONS FINISHING

01 BIANCO OPACO MATT WHITE	36 BEIGE OPACO MATT BEIGE	64 ANTRACITE OPACO MATT ANTHRACITE

FINITURE PIANO IN VETRO
GLASS TOP FINISHING

V601 EXTRA WHITE ACIDATO BIANCO EXTRA CLEAR ETCHED WHITE	V636 EXTRA WHITE ACIDATO BEIGE EXTRA CLEAR ETCHED BEIGE	V664 EXTRA WHITE ACIDATO ANTRACITE EXTRA CLEAR ETCHED ANTHRACITE

FINITURE PIANO E ALLUNGHE IN HPL LAMINATO
HPL LAMINATED TOP AND EXTENSIONS FINISHING

01 BIANCO OPACO MATT WHITE



eliseo

design_Studio 28

ELISEO_ART. 8028 TP/T

Tavolo tondo con base in metallo verniciato e piano in vetro temperato elettro- saldato a raggi UV su piastra d'acciaio, per il massimo della qualità e della ricercatezza estetica. Disponibile anche nella versione tricolore_

Round table with base in painted metal and top in tempered glass electro-welded with UV rays on steel plates for maximum quality and aesthetic design. Available also in the tricoloured version_

Misure_Sizes

TP Ø 120 H 75

T Ø 140 H 75

BIG ELISEO_ART. 8061 OK/OX/RK/RZ/EZ

Tavolo con vetro temperato sagomato e basi in metallo verniciato. Big Eliseo è perfetto per chi vuole rendere la propria sala unica con estrema pulizia formale ed esclusiva_

Table with shaped tempered glass and base in painted metal. Big Eliseo is perfect for those wishing their dining room to be unique with formal and exclusive lines_

Misure_Sizes

OK L 260 P 120 H 75

OX L 300 P 120 H 75

RZ L 240 P 120 H 75

RK L 300 P 120 H 75

EZ L 240 P 120 H 75



eliseo tricolore *design_Studio 28*

Eliseo realizzato in metallo curvato e verniciato si caratterizza per la base che disegna un segno grafico autentico e di forte presenza. Elegante e contemporaneo nella versione tricolore_

Eliseo made in curved and laquered metal features a base that shows an authentic distinguishing sign. Elegant and contemporary in the three-coloured version_



ELISEO

informazioni tecniche
technical sheets

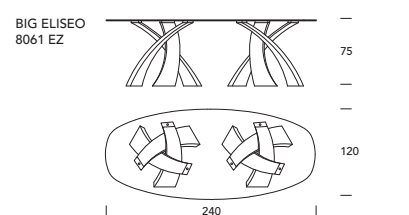
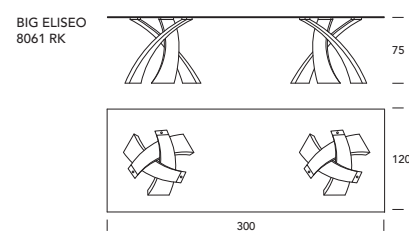
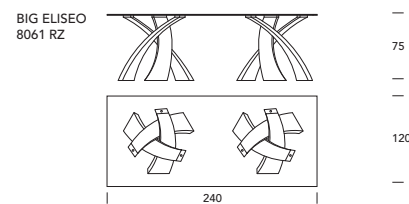
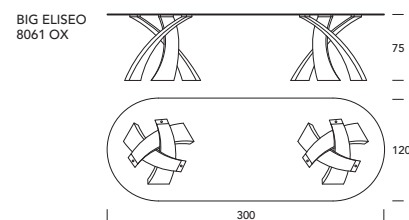
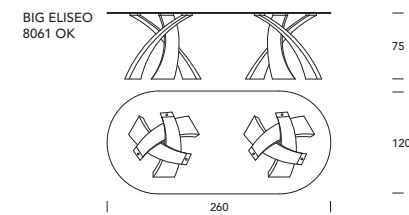
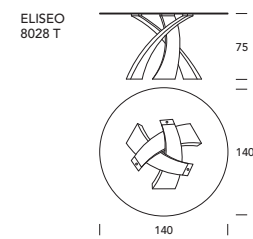
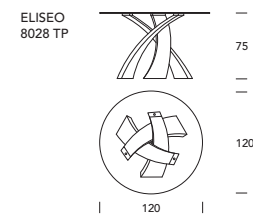

FINITURE BASE
STRUCTURE FINISHING

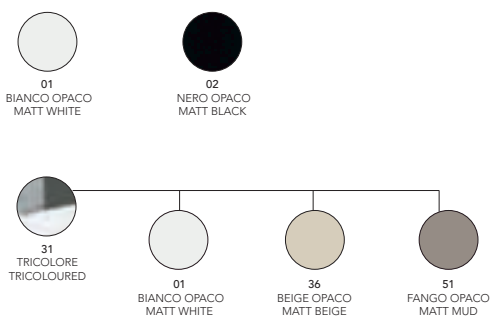

FINITURE PIANI
IN VETRO DI SERIE
GLASS TOP
STANDARD FINISHING



FINITURE PIANI IN VETRO
SU ORDINAZIONE
GLASS TOP
CUSTOMIZED FINISHING



ghost

design *Andrea Lucatello*

GHOST_ART. 8058 RZ/EZ

Tavolo fisso con basamento in vetro curvo spessore 19 mm e piano in vetro temperato. Una linea pulita e di estrema eleganza che nasce dall'utilizzo di un materiale prezioso come il vetro.

Fixed table with curved glass base of 19 mm. thickness, top in tempered glass. It has clean lines and is of extreme elegance which originates from the use of a precious material such as glass.

Misure_Sizes

RZ L 240 P 120 H 75

EZ L 240 P 120 H 75





GHOST
informazioni tecniche
technical sheets

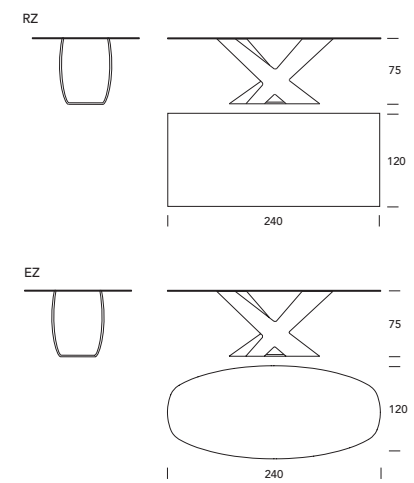

FINITURE BASE
STRUCTURE FINISHING



V81
TRASPARENTE
TRASPARENT



V100
EXTRA WHITE TRASPARENTE
EXTRA CLEAR TRASPARENT

FINITURE PIANI
IN VETRO DI SERIE
GLASS TOP
STANDARD FINISHING



V81
TRASPARENTE
TRASPARENT



V100
EXTRA WHITE TRASPARENTE
EXTRA CLEAR TRASPARENT



la defense

design_Nicola Tonin

LA DEFENSE_ART. 8045 TP/T

Tavolo tondo con base in agglomerato di marmo e piano in vetro temperato. La Defense è perfetto per chi vuole rendere eleganti anche gli spazi più piccoli dell'ambiente domestico_

Round table with base in agglomerated marble and top in tempered glass. La Defense is perfect for who wants to make elegant even the smallest spaces of the home environment_

Misure_Sizes

TP Ø 120 H 75

T Ø 140 H 75



LA DEFENSE

informazioni tecniche
technical sheets

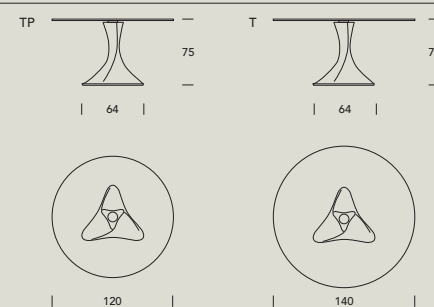

FINITURE BASE STRUCTURE FINISHING



S01
BIANCO LUCIDO
SHINING WHITE



S02
NERO LUCIDO
SHINING BLACK



S36
BEIGE LUCIDO
SHINING BEIGE

FINITURE PIANO VETRO DI SERIE GLASS TOP STANDARD FINISHING



V81
TRASPARENTE
TRANSPARENT

FINITURE PIANO VETRO SU ORDINAZIONE GLASS TOP CUSTOMIZED FINISHING



V100
EXTRA WHITE TRASPARENTE
EXTRA CLEAR TRANSPARENT

smart

design_Tonin Creatives

SMART_ART. 8066

Tavolo realizzato in alluminio con allunghe in HPL laminato.

Ideale per arredare gli spazi living sia in modo tradizionale sia con uno spiccato spirito contemporaneo_

Table in aluminium with extensions in HPL laminate.

Ideal for furnishing living spaces which may be either traditional or with a distinctive contemporary spirit_

Misure_Sizes

L 120/200 P 83 H 75



SMART

informazioni tecniche
technical sheets

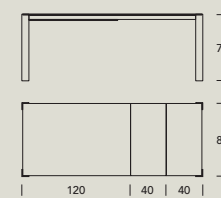

FINITURE STRUTTURA STRUCTURE FINISHING



01
ALLUMINIO VERNICIATO
BIANCO OPACO
MATT WHITE LACQUERED
ALUMINIUM



64
ALLUMINIO VERNICIATO
ANTRACITE OPACO
MATT ANTHRACITE
LACQUERED ALUMINIUM

FINITURE PIANO E ALLUNGHE IN HPL LAMINATO HPL LAMINATED TOP AND EXTENSIONS FINISHING



01
BIANCO OPACO
MATT WHITE



64
ANTRACITE OPACO
MATT ANTHRACITE

FINITURE PIANI IN VETRO DI SERIE GLASS TOP STANDARD FINISHING



V101
EXTRA WHITE BIANCO
EXTRA CLEAR WHITE



V164
EXTRA WHITE ANTRACITE
EXTRA CLEAR ANTHRACITE



bonton

design_Studio Archirivolto

BONTON_ART. 8059

Tavolo allungabile dal design "bonton". Perfetto per chi desidera un ambiente cucina originale ad un prezzo decisamente conveniente.

Realizzato in metallo laccato e piano in nobilitato si presta ad arredare con classe anche gli ambienti più semplici.

Extendible table of "bonton" design. Perfect for those who desire an original kitchen room at an affordable price. Made in lacquered metal with top in laminate, ideal for furnishing even the most simple room with class.

Misure_Sizes

L 130/180 P 80 H 75



BONTON

informazioni tecniche
technical sheets



FINITURA STRUTTURA STRUCTURE FINISHING



01
BIANCO OPACO
MATT WHITE

FINITURE PIANO E ALLUNGHE IN NOBILITATO FACED TOP AND EXTENSION STANDARD FINISHING



01
BIANCO OPACO
MATT WHITE



36
BEIGE OPACO
MATT BEIGE

A close-up photograph of a modern chair's seat and leg. The seat is upholstered in a smooth, teal-colored leather with visible stitching along the edges. A polished chrome metal leg is attached to the underside of the seat. The background is a neutral, light gray surface.

simply
lisetta
regina
sorbona
round
soft
cover
aria easy
hole
mary
calice

sedute_seats

simply

design_Angelo Tomaiuolo

SIMPLY_ART. 7206

Seduta, poltroncina in cuoio con struttura in metallo cromato o laccato.

Dalle idee più semplici nasce il design perfetto, per rendere ogni ambiente unico ed inimitabile_

Chair, armchair in thick leather curved with structure in chromed metal or lacquered. The perfect design originates from the most simple ideas, to make every room unique and inimitable_

Misure_Sizes

L 54 P 53 H 48/78



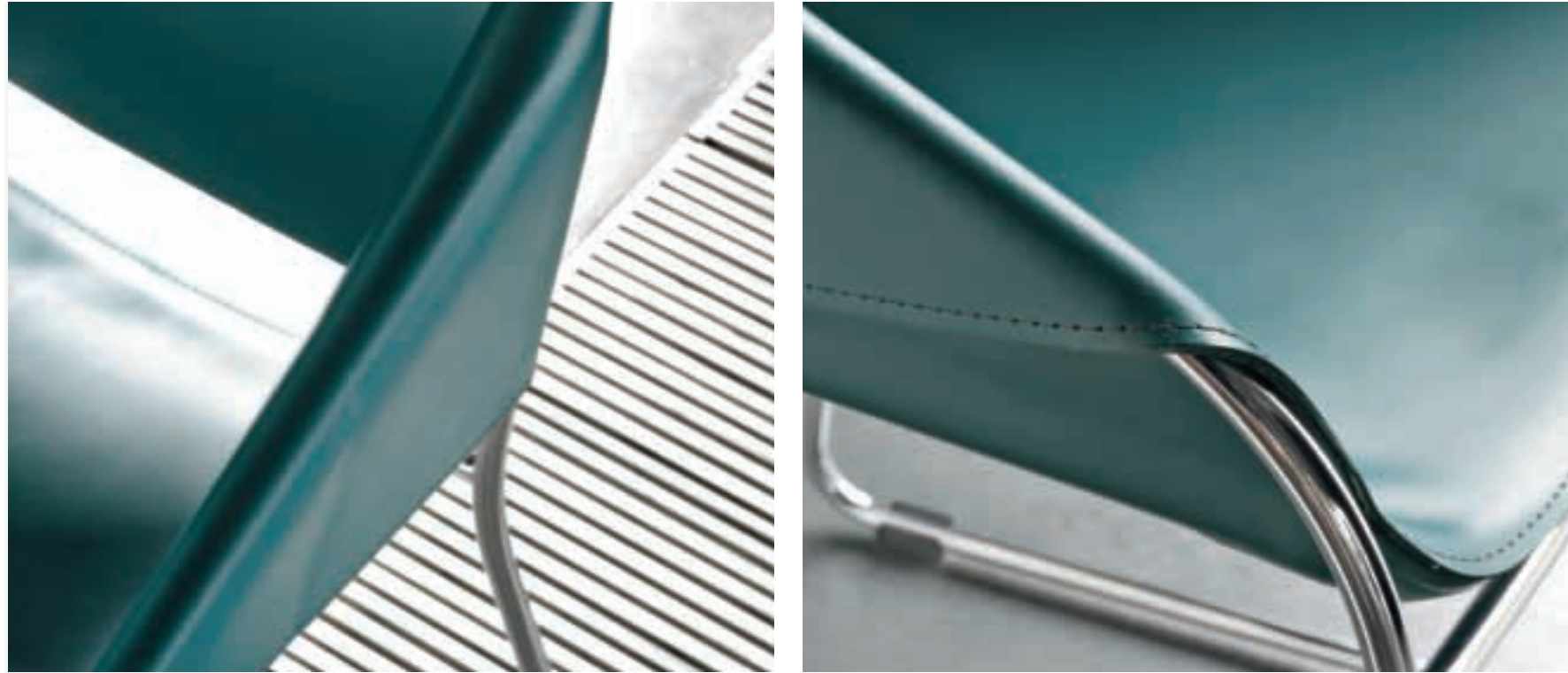

SIMPLY
informazioni tecniche
technical sheets

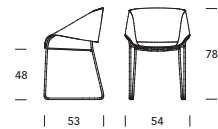

FINITURE STRUTTURA
STRUCTURE FINISHING



01
BIANCO OPACO
MATT WHITE



72
METALLO CROMATO
CHROMED METAL

FINITURE SEDUTA
SEAT FINISHING



K
CUOIO
THICK LEATHER



KN32
NATURALE NUVOLATO
NATURALLY CLOUDED

PER IL CAMPIONARIO COMPLETO
VEDI LE PAGINE FINALI
FOR THE COMPLETE SAMPLE
SEE THE FINAL PAGES



lisetta

design_Angelo Tomaiulo

LISSETTA_ART. 7200

Seduta realizzata in poliuretano schiumato a freddo, completamente rivestita in pelle, eco pelle o tessuto. Lisetta è pensata per chi vuole un design nuovo dalle linee morbide e decisamente distinguibili, grazie anche alle impeccabili cuciture che ne determinano il prestigio_

Seat made in cold foamed polyurethane, completely upholstered in leather, eco leather or fabric. Lisetta is thought for those looking for a new design with soft but distinctive lines, thanks to the impeccable stitching which confers prestige_

Misure_Sizes

L 51 P 57 H 46/103





LISETTA
informazioni tecniche
technical sheets

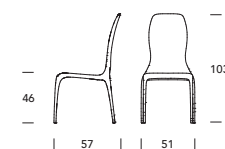

RIVESTIMENTO
COVERING

PER IL CAMPIONARIO COMPLETO
VEDI LE PAGINE FINALI
FOR THE COMPLETE SAMPLE
SEE THE FINAL PAGES



P
PELLE
LEATHER



PF
PELLE FIORE
LEGGGERMENTE RITOCOCATO
GRAIN LEATHER
SLIGHTLY IMPROVED



S
ECO PELLE
ECO LEATHER



TV
TESSUTO VERBENA
VERBENA FABRIC



TN
TESSUTO NINFEA
NINFEA FABRIC



regina

design_Studio Archirivolto

REGINA_ART. 7201

Seduta realizzata in poliuretano schiumato a freddo, completamente rivestita in pelle, eco pelle o tessuto. Design tondeggiante, totale fluidità delle linee ed eleganza fuori dagli schemi per una sedia che si presenta compatta e maneggevole adatta a qualsiasi tavolo_

Seat made in cold foamed polyurethane, completely upholstered in leather, eco leather or fabric. Rounded design, total fluidity of lines and elegance out of the norm for a chair which is compact and manageable, suitable for any table_

Misure_Sizes

L 47 P 53 H 46/81





REGINA
informazioni tecniche
technical sheets

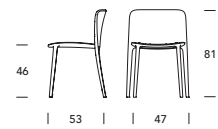

RIVESTIMENTO
COVERING

PER IL CAMPIONARIO COMPLETO
VEDI LE PAGINE FINALI
FOR THE COMPLETE SAMPLE
SEE THE FINAL PAGES



P
PELLE
LEATHER



PF
PELLE FIORE
LEGGGERMENTE RITOCOCATO
GRAIN LEATHER
SLIGHTLY IMPROVED



S
ECO PELLE
ECO LEATHER



TV
TESSUTO VERBENA
VERBENA FABRIC



TN
TESSUTO NINFEA
NINFEA FABRIC



sorbona

design_Studio 28

SORBONA_ART. 7295

Seduta realizzata in poliuretano schiumato a freddo, completamente rivestita in pelle, eco pelle. Sorbona è pensata per chi vuole la massima eleganza_

Seat made in foamed polyurethane, completely upholstered in leather, eco leather. Sorbona is designed for people who want the utmost elegance_

Misure_Sizes

L 45 P 52 H 48/108

SORBONA
informazioni tecniche
technical sheets

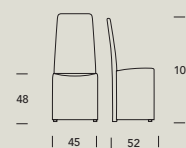

RIVESTIMENTO
COVERING



P
PELLE
LEATHER



PF
PELLE FIORE
LEGGERMENTE RITOCATO
GRAIN LEATHER
SLIGHTLY IMPROVED



S
ECO PELLE
ECO LEATHER

PER IL CAMPIONARIO COMPLETO
VEDI LE PAGINE FINALI
FOR THE COMPLETE SAMPLE
SEE THE FINAL PAGES



round

design_Tonin Creative

ROUND_ART. 7211

Seduta imbottita in gomma indeformabile ad alta densità. Round è stata progettata con forme morbide e tondeggianti per rendere gli ambienti armoniosi. Disponibile in eco pelle e pelle in svariate colorazioni_

Seat padded in non deformable high density rubber. Round was conceived with soft and rounded forms to make the environment harmonious.

Available in eco leather and leather in many colours_

Misure_Sizes

L 43 P 53 H 48/88



ROUND

informazioni tecniche
technical sheets



FINITURE
FINISHING

PER IL CAMPIONARIO COMPLETO
VEDI LE PAGINE FINALI
FOR THE COMPLETE SAMPLE
SEE THE FINAL PAGES



P
PELLE
LEATHER



S
ECO PELLE
ECO LEATHER

soft

design_Tonin Creative

SOFT_ART. 7210

Seduta imbottita in gomma indeformabile ad alta densità. Soft è semplice ma studiata per dare il massimo del comfort negli ambienti domestici.

Disponibile in eco pelle e pelle in svariate colorazioni_

Seat padded in non deformable high density rubber. Soft is simple but designed to give the maximum of comfort for domestic ambiances.

Available in eco leather and leather in many colours_

Misure_Sizes

L 42 P 53 H 48/92



SOFT
informazioni tecniche
technical sheets

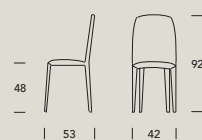

FINITURE
FINISHING

PER IL CAMPIONARIO COMPLETO
VEDI LE PAGINE FINALI
FOR THE COMPLETE SAMPLE
SEE THE FINAL PAGES



P
PELLE
LEATHER



S
ECO PELLE
ECO LEATHER



cover

design_Studio 28

COVER_ART. 7205

Sedia Cover si veste con i colori più sgargianti per dare ai tuoi ambienti un tocco decisamente glamour. La seduta viene interamente rivestita in tessuto per permettere gli abbinamenti più originali e personalizzati_

Cover chair dresses itself with bright colours to give your environment a distinctive touch of glamour. The seat is entirely covered in fabric to allow the most original and personalised matching_

Misure_Sizes
L 50 P 50 H 46/84



COVER

informazioni tecniche
technical sheets

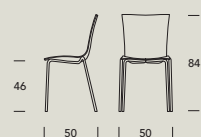

FINITURE STRUTTURA STRUCTURE FINISHING



01
BIANCO OPACO
MATT WHITE



72
METALLO CROMATO
CHROMED METAL

FINITURE SEDUTA SEAT FINISHING



TV
TESSUTO VERBENA
VERBENA FABRIC



TN
TESSUTO NINFEA
NINFEA FABRIC



TK
TESSUTO MIMOSA
MIMOSA FABRIC

PER IL CAMPIONARIO COMPLETO
VEDI LE PAGINE FINALI
FOR THE COMPLETE SAMPLE
SEE THE FINAL PAGES



aria easy

design_Studio 28

ARIA EASY_ART. 7204

Sedia impilabile stampata in policarbonato con struttura in metallo cromato o verniciato. Aria è semplicemente espressione di resistenza, leggerezza e semplicità_

Stackable chair moulded in polycarbonate with structure in chromed metal or painted. Aria is simply an expression of resistance lightness and simplicity_

Misure_Sizes

L 50 P 50 H 46/84





ARIA EASY
informazioni tecniche
technical sheets

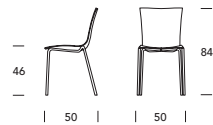

FINITURE STRUTTURA
STRUCTURE FINISHING



01
BIANCO OPACO
MATT WHITE



72
METALLO CROMATO
CHROMED METAL

FINITURE SEDUTA
SEAT FINISHING



81
TRASPARENTE
TRANSPARENT



85
FUMÉ TRASPARENTE
TRANSPARENT FUMÉ



501
BIANCO LUCIDO
SHINING WHITE



502
NERO LUCIDO
SHINING BLACK



hole

design_Studio Archirivolto

HOLE_ART. 7207

Seduta stampata in polipropilene, materiale di ultima generazione eco sostenibile ed eccezionalmente resistente. Struttura in metallo cromato o verniciato. Hole è disponibile in diverse colorazioni, pensata sia per l'ambiente cucina sia per il settore contract_

Seat moulded in Polypropylene, a new generation material environmentally friendly and exceptionally resistant. Structure in chromed metal or painted. Hole is available in many colours, thought for both the kitchen and for the contract sector_

Misure_Sizes

L 45 P 56 H 45/86





HOLE
informazioni tecniche
technical sheets

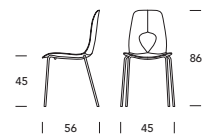

FINITURE STRUTTURA
STRUCTURE FINISHING



01
BIANCO OPACO
MATT WHITE



72
METALLO CROMATO
CHROMED METAL

FINITURE SEDUTA
SEAT FINISHING



01
BIANCO OPACO
MATT WHITE



18
GRIGIO SABBIA OPACO
MATT GREY SAND



51
FANGO OPACO
MATT MUD



59
GIALLO SENAPE OPACO
MATT YELLOW MUSTARD

mary

design_Studio Archirivolto

MARY_ART. 7202

Sedia impilabile stampata in poliuretano rigido disponibile in diverse colorazioni. Da un design puramente vintage nasce Mary, la seduta che non vuole abbandonare le linee classiche di un tempo senza nascondere il suo carattere più giovane e moderno_

Stackable chair moulded in rigid polyurethane available in different colours. Mary originates from a purely vintage design, a seating which does not want to abandon its classic lines from the past without hiding its younger and more modern character_

Misure_Sizes

L 46 P 51 H 46/82



MARY
informazioni tecniche
technical sheets



FINITURE COLORE
COLORS FINISHING



01
BIANCO OPACO
MATT WHITE



36
BEIGE OPACO
MATT BEIGE



64
ANTRACITE OPACO
MATT ANTHRACITE



calice

design_Angelo Tomaiuolo

CALICE_ART. 6325

Sgabello realizzato tramite tecnologia ad iniezione di poliuretano per la creazione di un prodotto unico che può essere personalizzato scegliendo il colore più affine alla propria fantasia per la seduta imbottita. Calice è bellezza estetica sia per gli ambienti domestici sia per le forniture contract più esigenti_

Stool made by injection technology of polyurethane for the creation of a unique product which may be personalised by choosing the colour most akin to one's fantasy for the padded seating. Calice is aesthetic beauty for both the domestic environment and the most demanding contract requests_

Misure_Sizes

L 45 P 45 H 68/88 - 59/79

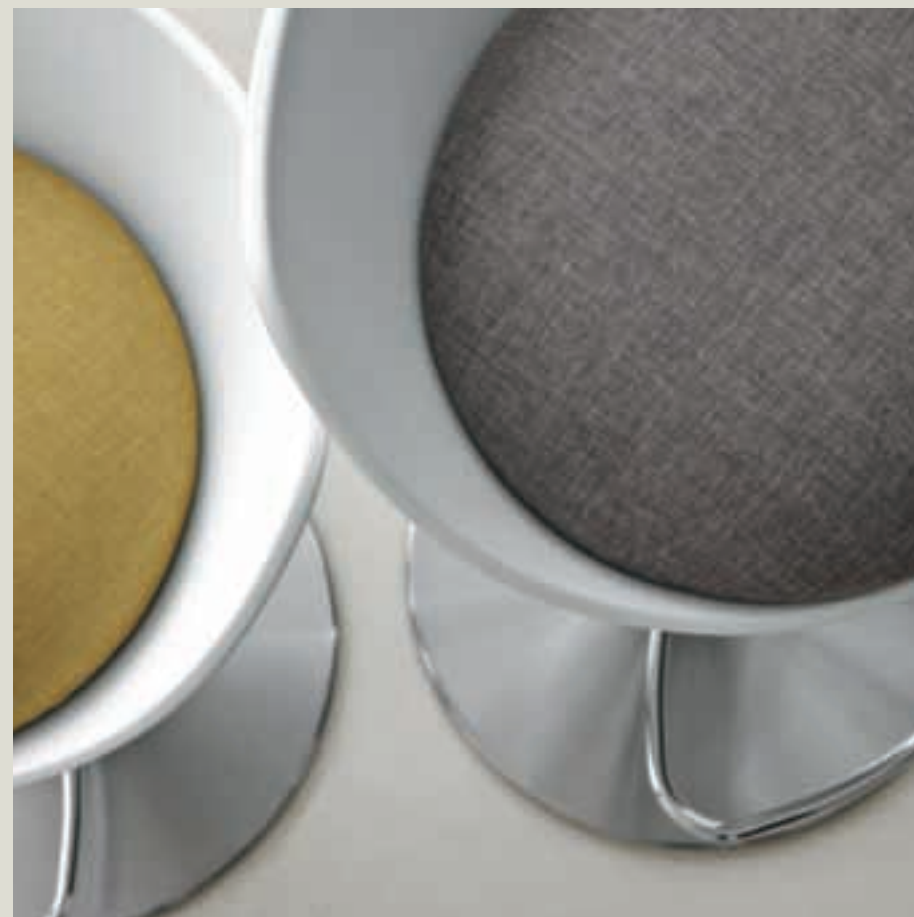

CALICE

informazioni tecniche
technical sheets

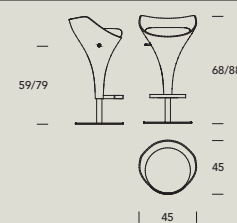

FINITURE STRUTTURA STRUCTURE FINISHING



01
BIANCO OPACO
MATT WHITE



02
NERO OPACO
MATT BLACK

RIVESTIMENTO SEDUTA SEAT COVERING



TO
TESSUTO ORCHIDEA
ORCHIDEA FABRIC



TN
TESSUTO NINFEA
NINFEA FABRIC



S
ECO PELLE
ECO LEATHER

SELEZIONE TESSUTI SCELTI PER QUESTO PRODOTTO SELECTION FABRIC CHOSEN FOR THIS PRODUCING

TO1
TO2
TO40
TO41
TO51

TN04
TN16
TN17
TN29
TN65

S01
S02
S03
S29
S44
S51
S60
S74



onda
bands
pois
goya
leaves
leaves living

conte
nitori_
storage
units

onda

design_Angelo Tomaiuolo

ONDA_ART. 7318 / ART. 7319

Libreria in MDF laccato autoportante e ripiani in cristallo extra chiaro trasparente. Onda è un oggetto di design estremamente versatile poiché strutturata a moduli che possono essere disposti sia in verticale che in orizzontale per un “effetto onde” senza limiti_

Self supporting library unit in lacquered MDF with extra clear glass shelves. Onda is an object of design extremely versatile with structure in modules which may be arranged both vertically and horizontally for a “wave effect” without limits_



Composizione A / Composition A

Misure_Sizes

L 200 P 38,5 H 173



ONDA
informazioni tecniche
technical sheets

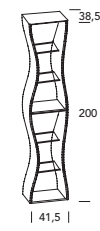

ART. 7318 V
ART. 7318 VDX
ART. 7318 VSX
ART. 7318 VCX

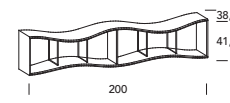

ART. 7318 ODX
ART. 7318 OSX
ART. 7318 OCK

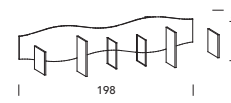

ART. 7319

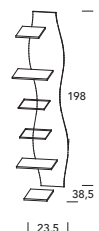

ART. 7323

FINITURE STRUTTURA
STRUCTURE FINISHING



01 BIANCO OPACO
MATT WHITE



36 BEIGE OPACO
MATT BEIGE

RIPIANI IN VETRO
EXTRA WHITE TRASPARENTE
GLASS SHELVES
EXTRA CLEAR TRASPARENT

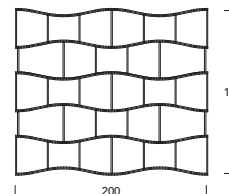

COMPOSIZIONE A / COMPOSITION A
L200 P38,5 H173
N. 1_7318 ODX + N. 2_7319 +
N.1_7318 OCK + N. 1_7318 OSX

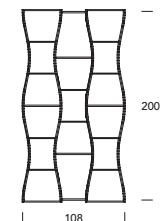

COMPOSIZIONE B / COMPOSITION B
L108 P38,5 H200
N. 1_7318 VSX + N. 1_7319 +
N. 1_7318 VDX



Composizione B / Composition B
Misure_Sizes
L 108 P 38,5 H 200

bands

design_Nicola Tonin

BANDS_ART. 8251 Madia a 2 ante.

BANDS_ART. 8251 G Madia a 3 ante.

Top in vetro extrachiaro verniciato in colore struttura base. La casa rivive in un nuovo elemento, uno spazio distintivo che rende i mobili unici per definizione. L'immagine che ne deriva adorna con gusto delicato e sobrio un contesto raffinato ed esclusivo. Intreccio di curve e linee che si elevano in una primaria unione_

Extra clear top glass painted like structure. The home re-lives in a new element, a distinctive space that makes the furniture unique by definition. The image derived adorns with a delicate and sober taste, creating a refined and exclusive interior. Interwoven curves and lines which elevate themselves in a primary union_

Misure_Sizes

Art. 8251 L 168 P 50 H 77

Art. 8251 G L 204 P 50 H 77

BANDS

informazioni tecniche
technical sheets

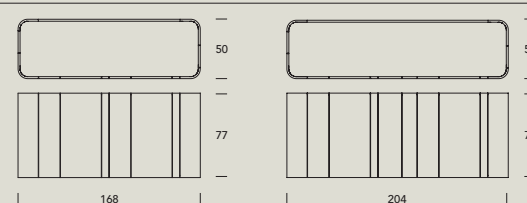

FINITURA STRUTTURA
STRUCTURE FINISHING



01
BIANCO OPACO
MATT WHITE



36
BEIGE OPACO
MATT BEIGE

TOP IN VETRO EXTRACHIAIRO ACIDATO VERNICIATO IN TINTA CON LA STRUTTURA
E RIPIANI INTERNI IN VETRO EXTRA WHITE TRASPARENTE
EXTRA CLEAR ETCHED GLASS TOP MATCHING THE STRUCTURE AND INTERNAL
SHELVES IN EXTRA CLEAR TRASPARENT

OPTIONAL LUCE LED PER TOP VETRO
OPTIONAL LED LIGHT FOR THE GLASS TOP





Bands originale per la sua forma sinuosa e per le linee verticali che disegnano le ante. Madia progettata per essere collocata in ogni spazio della casa. In questa foto nella raffinata versione "total white": laccata bianco opaco e top in vetro verniciato bianco.

Bands thanks to its sinuous shape and to its vertical lines that draw the doors, is a very original concept. Sideboard created to be placed in every room. In this photo, it is in the refined version "total white": laquered in matt white and extra white glass top.



pois

design_Angelo Tomaiuolo e Nicola Tonin

POIS_ART. 8503/8504/8505/8506/8507/8508

*Madia impiallacciata noce canaletto o laccato opaco,
antine in metallo decorate a laser.*

Linee pulite e minimali per un effetto optical_

*Sideboard in veneered black walnut or matt laquered,
laser decored metal doors. clean and minimal
lines to create an optical illusion_*

Misure_Sizes

Art. 8503/8504/8505 L 184 P 51 H 67

Art. 8506/8507/8508 L 244 P 51 H 67



pois design_Angelo Tomaiuolo e Nicola Tonin

Linee semplici, design rigoroso, materiali naturali come il legno, accostati in modo inedito all'alluminio laccato e colorato. Un nuovo concetto di madia per arredare con creatività gli spazi domestici_

Simple lines, rigorous design, natural materials such as wood, side by side in an unusual way with aluminium, lacquered and coloured. A new concept of cupboards for furnishing domestic spaces with creativity_





POIS_ART. 8504



POIS
informazioni tecniche
technical sheets

			FINITURE STRUTTURA ESTERNA E CASSETTI EXTERNAL STRUCTURE FINISHING AND DRAWERS					
			01 BIANCO OPACO MATT WHITE	14 NOCE CANALETTO BLACK WALNUT	36 BEIGE OPACO MATT BEIGE			
			FINITURE ANTE DOORS FINISHING					
			01 BIANCO OPACO MATT WHITE	07 AZZURRO OPACO MATT LIGHT BLUE	36 BEIGE OPACO MATT BEIGE	51 FANGO OPACO MATT MUD	59 GIALLLO SENAPE OPACO MATT MUSTARD YELLOW	
			FINITURE BOX INTERNI BOX INTERIOR FINISHING					
			01 BIANCO OPACO MATT WHITE	07 AZZURRO OPACO MATT LIGHT BLUE	36 BEIGE OPACO MATT BEIGE	51 FANGO OPACO MATT MUD	59 GIALLLO SENAPE OPACO MATT MUSTARD YELLOW	



POIS_ART. 8503

goya

design_Studio 28

GOYA_ART. 6107

Madia realizzata in MDF microgoffrato laccato opaco.

Goya è perfetta per chi vuole praticità e massima qualità. L'apertura coplanare, infatti, permette di ottimizzare gli spazi senza rinunciare al design. Disponibile anche con kit luce_

Sideboard in micro embossed matt laquered MDF.

Goya is perfect for convenience and quality.

Indeed the coplanar opening allows to optimize space whilst holding on to the design.

Available also with light kit_

Misure_Sizes

L 220 P 55 H 76



GOYA

informazioni tecniche
technical sheets

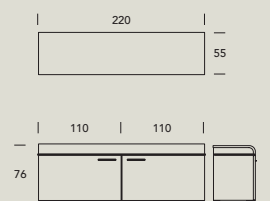

FINITURE STRUTTURA
STRUCTURAL FINISHING



01
BIANCO OPACO
MATT WHITE



02
NERO OPACO
MATT BLACK



36
BEIGE OPACO
MATT BEIGE

OPTIONAL LUCE A LED
OPTIONAL LIGHT LED

leaves

design_Angelo Tomaiuolo

LEAVES_ART. 8540/8541/8542/8543

Geometrie lineari e design organico per Leaves, una collezione di contenitori che prende ispirazione dalla natura. La delicatezza di una foglia stampata in tridimensionale per creare le composizioni più svariate ed originali. Per chi desidera una casa fortemente personale tutta da vivere. Una casa che non necessita d'essere grande per essere bella, ma che viene pensata con funzionalità e personalizzazione per dare forma alle emozioni di ognuno_

Linear geometries and organic design for Leaves, a collection of storage units which takes inspiration from nature. The delicacy of a three dimensional moulded leaf to create the most varied and original compositions. For those who desire a strongly personal home to live fully. A home which does not need to be large in order to be beautiful but is thought with functionality and personalization to in order give form to each one's emotions_

Misure_Sizes

Art. 8540 L 125 P 48 H 79

Art. 8541 L 240 P 48 H 79

Art. 8542 L 125 P 48 H 138

Art. 8543 L 170 P 48 H 79





leaves design_Angelo Tomaiuolo



LEAVES

informazioni tecniche
technical sheets

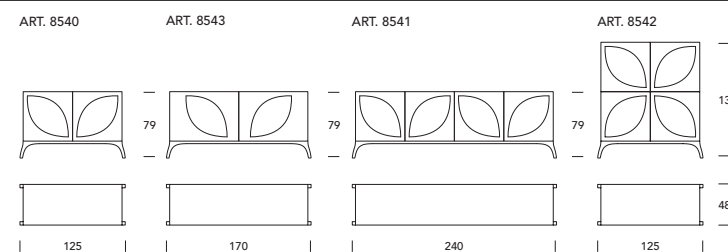

FINITURE STRUTTURA
E CASSETTI IN TINTA
FINISHINGS STRUCTURE AND
MATCHING DRAWERS



OPTIONAL CASSETTI INTERNI
OPTIONAL INTERNAL DRAWERS

leaves living

design_Angelo Tomaiuolo

LEAVES LIVING

Geometrie lineari e design organico per Leaves, una collezione di contenitori che prende ispirazione dalla natura. La delicatezza di una foglia stampata in tridimensionale per creare le composizioni più svariate ed originali. Per chi desidera una casa fortemente personale tutta da vivere. Una casa che non necessita d'essere grande per essere bella, ma che viene pensata con funzionalità e personalizzazione per dare forma alle emozioni di ognuno_

Linear geometries and organic design for Leaves, a collection of storage units which takes inspiration from nature. The delicacy of a three dimensional moulded leaf to create the most varied and original compositions. For those who desire a strongly personal home to live fully. A home which does not need to be large to be beautiful but which is thought with functionality and personalization to give form to each one's emotions_

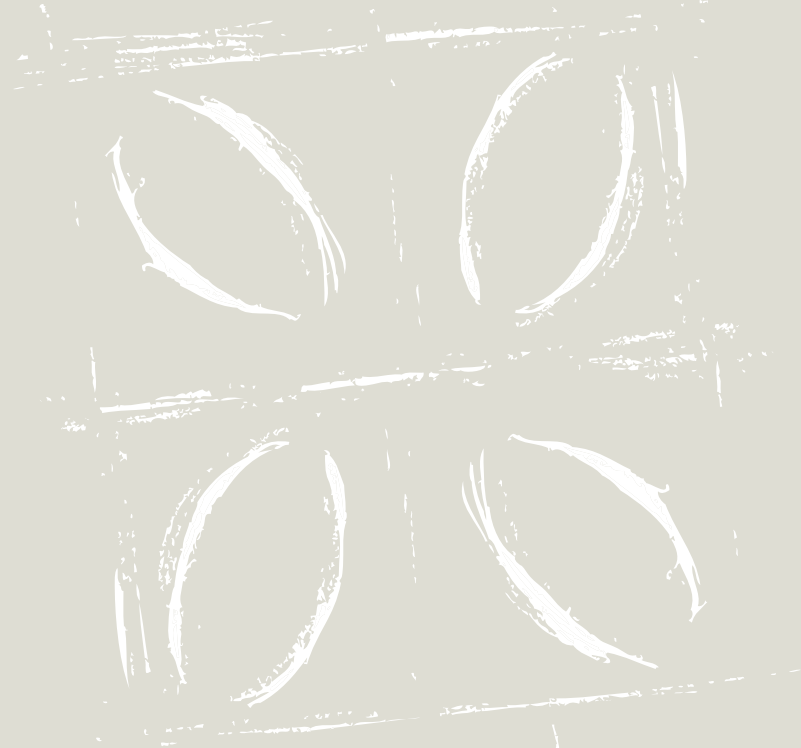



Composizione G / Composition G

Misure_Sizes

L 320 P 55 H 200



Leaves è un sistema versatile per tutti gli ambienti della casa.

Contenitori, pensili componibili, ripiani e cassettiere per creare infinite composizioni. Basi attrezzate di diverse dimensioni, dove trovano spazio TV ed altri elementi multimediali_

Leaves is a versatile modular system for all ambiances of the home.

Containers, modular cupboards, shelves and drawer units to create infinite compositions. Equipped bases of different dimensions, an ideal space for the TV and other multimedia elements_



leaves living *design_Angelo Tomaiuolo*

Composizione F / Composition F

Misure_Sizes

L 320 P 55 H 225



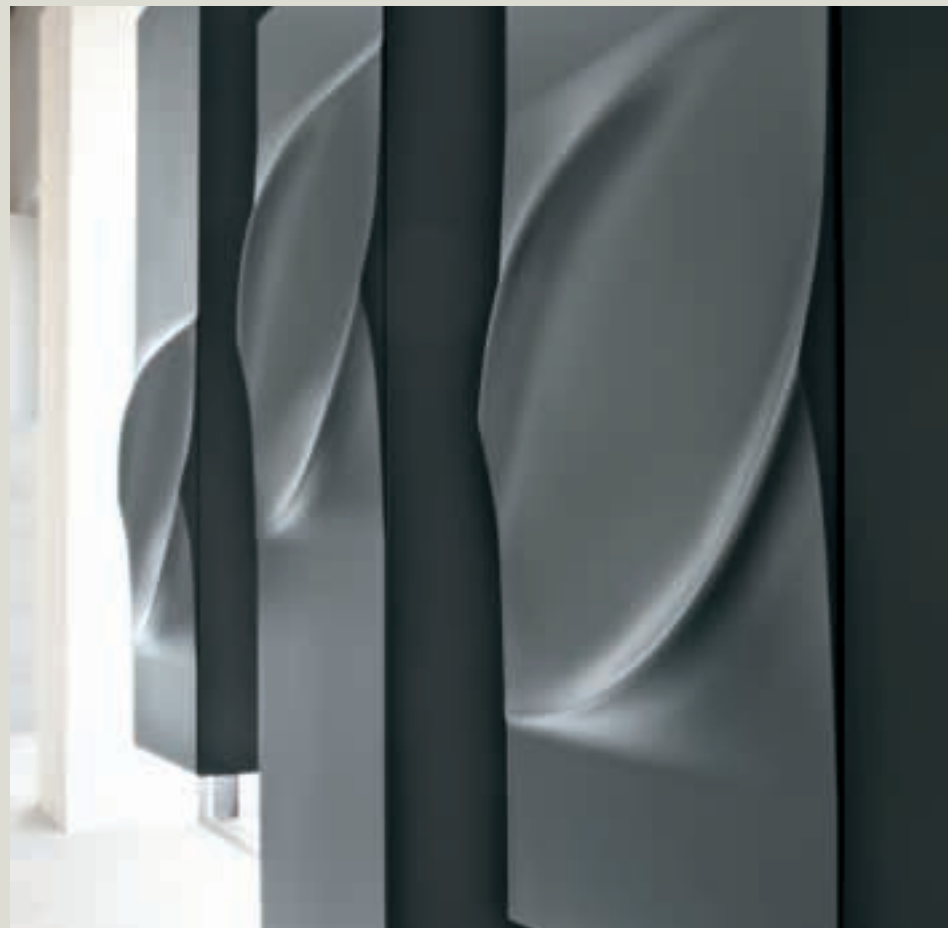

*Il disegno delle ante gioca con il modulo della "foglia"
creando un movimento dinamico delle linee.
In questa composizione l'elegante abbinamento chiaro
e scuro crea un'atmosfera di grande effetto_*

*The doors design plays with the "leaf" section creating
a movement of the lines. In this composition, the elegant
matching of light and dark, creates an impressive
atmosphere_*



leaves living *design_Angelo Tomaiuolo*

Composizione H / Composition H

Misure_Sizes

L 281 P 55 H 240



PENSILI SOSPESI
HANGING ELEMENTS

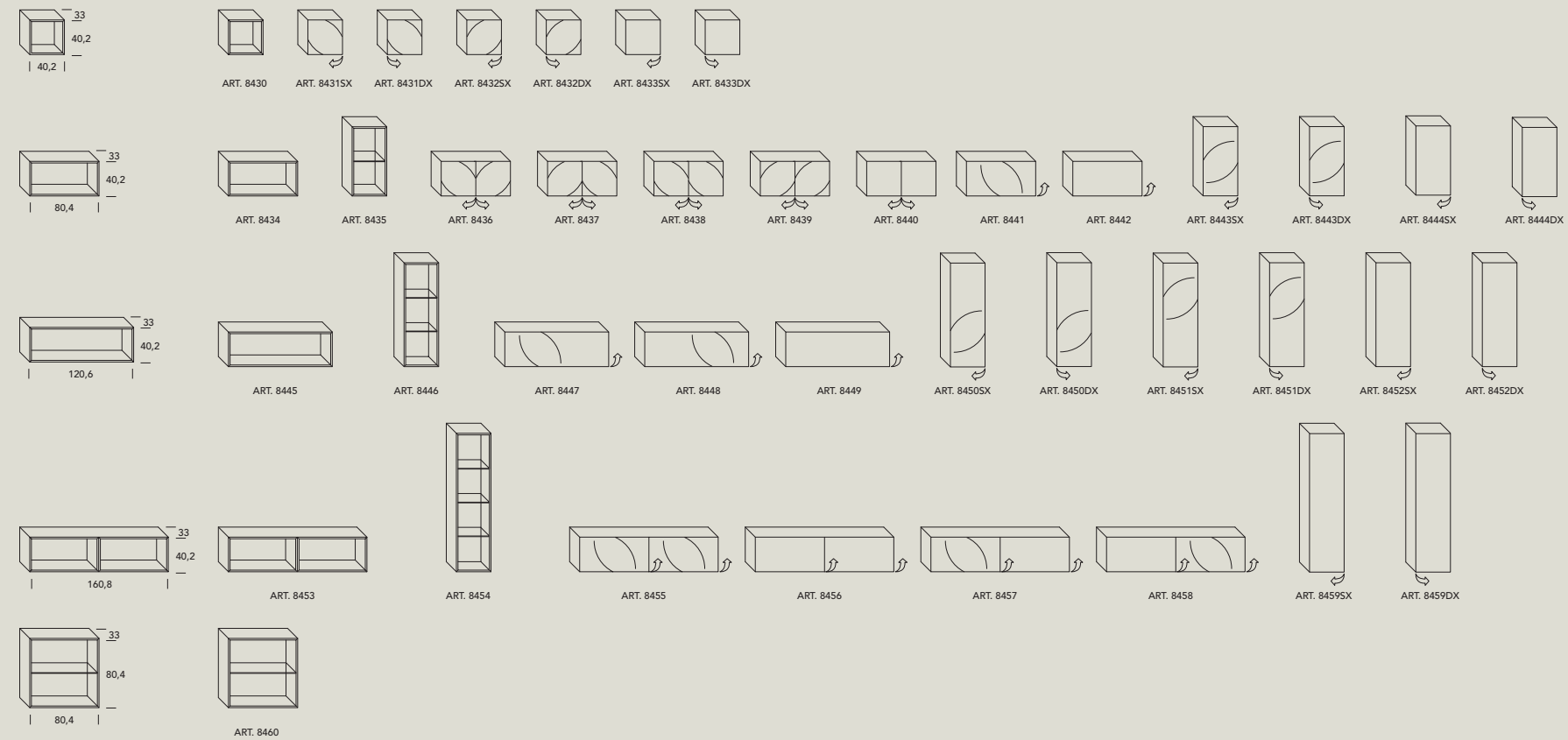

BOX A TERRA
BASES

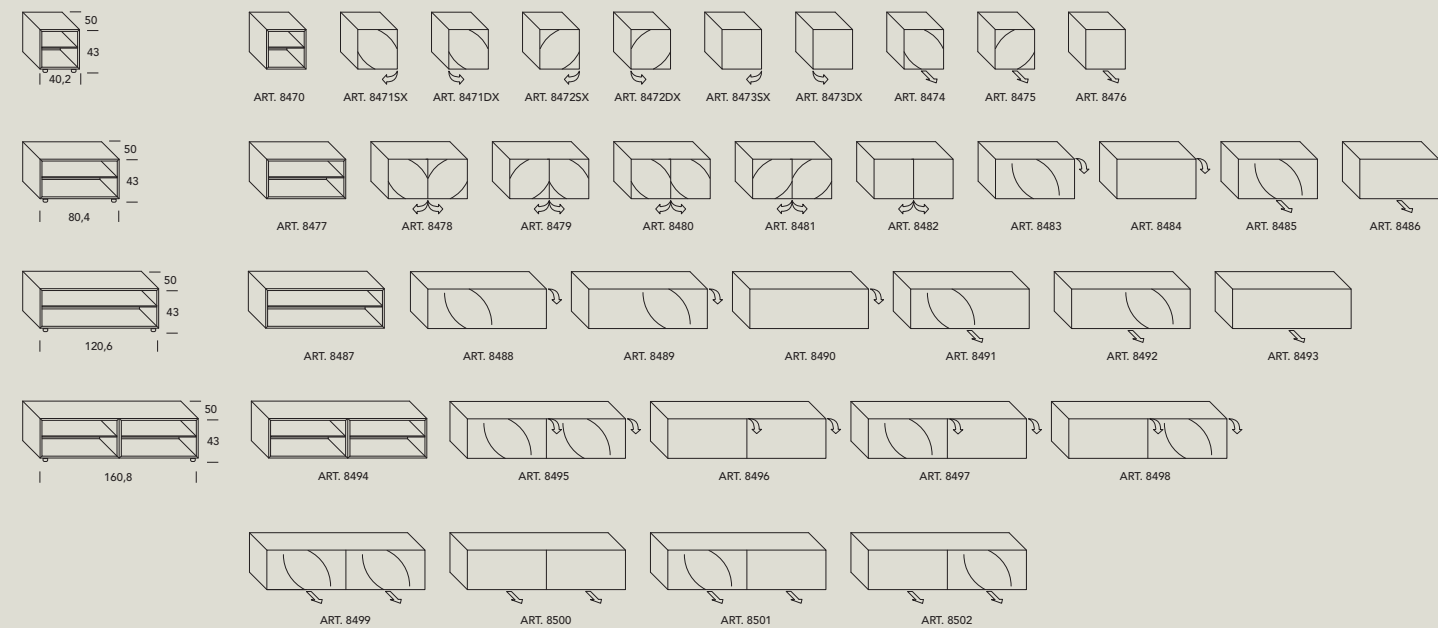

ACCESSORI SU ORDINAZIONE
CUSTOMIZED ACCESSORIES

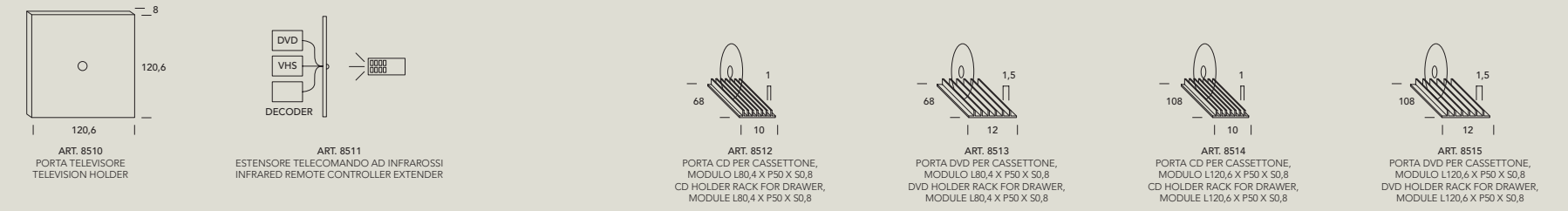

PIANI IN VETRO SU ORDINAZIONE
CUSTOMIZED GLASS TOP

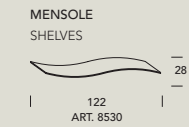

FINITURE STRUTTURA (SCHIENA LAMINATA BIANCA DI SERIE)
STRUCTURAL FINISHING (WHITE LAMINATED BACK AS STANDARD)



FINITURE SCHIENE SU ORDINAZIONE
BACKS CUSTOMIZED FINISHING



FINITURE TOP IN VETRO SU ORDINAZIONE
GLASS TOP CUSTOMIZED FINISHING



FINITURE PORTA TV
TV STANDS FINISHING



FINITURE MENSOLE
SHELVES FINISHING





divani e
poltrone
sofas and
armchairs

duny
blum
playa buena
ricciolo
nolita

duny

design_Angelo Tomaiuolo

DUNY_ART. 7380

Divano a tre posti disponibile in diverse finiture e colorazioni.

Estrema qualità dei dettagli, affidabilità delle strutture, un procedimento sartoriale che permette di enfatizzare forme particolari. Un design inedito per il massimo livello qualitativo_

Three seater sofa available in different finishings and colours.

Extreme quality of details, reliability of the structure and a tailoring procedure which enhances special shapes. A new design with the maximum level of quality_

Misure_Sizes

L 237 P 100 H 40/76

DUNY

informazioni tecniche
technical sheets

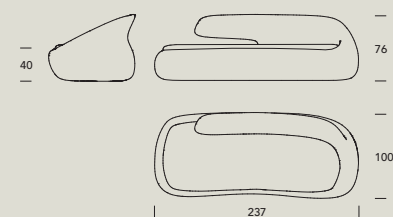

FINITURE BASE
STRUCTURE FINISHING



P
PELLE
LEATHER



PF
PELLE FIORE
LEGGERMENTE RITOCATO
GRAIN LEATHER
SLIGHTLY IMPROVED



S
ECO PELLE
ECO LEATHER

PER IL CAMPIONARIO COMPLETO
VEDI LE PAGINE FINALI
FOR THE COMPLETE SAMPLE
SEE THE FINAL PAGES





blum

design_Alessandro Crosera

BLUM

Divano componibile dalla funzionalità massima data dal meccanismo automatico che permette di regolare l'altezza dello schienale, garantendo il giusto comfort senza rinunciare al design. Blum è disegnato in ogni suo dettaglio ed è disponibile in diverse finiture. Bordino a contrasto o in tinta per i tessuti_

Modular sofa with maximum functionality given by the automatic mechanism which allows regulation of the height of back support, guaranteeing the right comfort without renouncing to design. Blum is designed in every single detail and is available in various finishings. Edge border available in the same colour or in contrast, for fabrics only_



blum *design_Alessandro Crosera*

Composizione E / Composition E

Misure_Sizes

L 336 P 150 H 72



BLUM
informazioni tecniche
technical sheets

Moduli chaise longue
/ Chaise longue modules

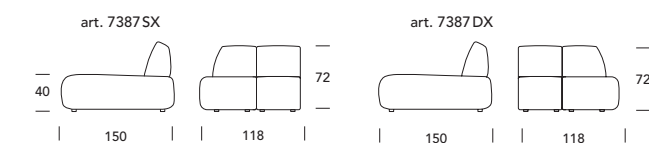

Modulo poltrona
/ Armchair module

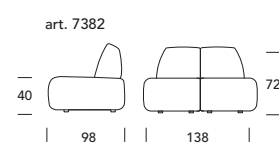

Moduli /Modules

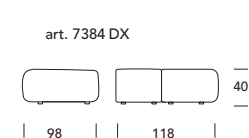
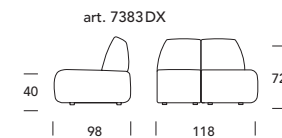
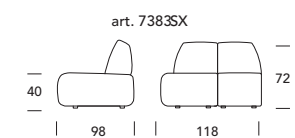
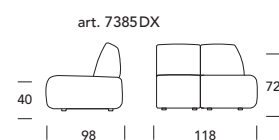
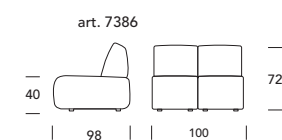
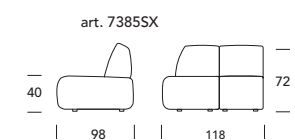

* Abbinabile solo con art 7384 DX
Combined with the art 7384 DX

* Abbinabile solo con art 7384 SX
Combined with the art 7384 SX

FINITURE RIVESTIMENTO
COVERING FINISHING

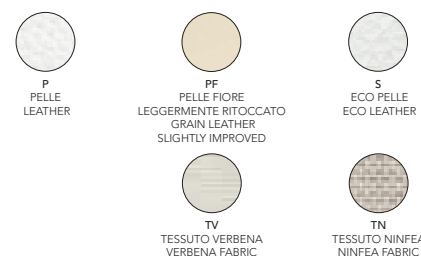

PER IL CAMPIONARIO COMPLETO
VEDI LE PAGINE FINALI
FOR THE COMPLETE SAMPLE
SEE THE FINAL PAGES

PER LE FINITURE DEL BORDINO VEDI LISTINO PREZZI
EDGE FINISHING LOOK THE LIST PRICE
OPTIONAL SCHIENALE REGOLABILE (VEDI LISTINO PREZZI)
OPTIONAL ADJUSTABLE BACKREST (LOOK THE LIST PRICE)



Composizione A / Composition A
Misure_Sizes
L 236 P 98 H 72

playa buena

design_Studio 28

PLAYA BUENA_ART. AT04

Lo stile fa mostra di sé, impeccabile, eclettico e seducente, nella bellezza dei suoi contrasti. Linee dritte per le sedute, gli schienali che interpretano in maniera originale il vero lusso del nostro tempo. Disponibile nelle versioni DRAPE con rivestimento in tessuto e CAPITONNÉ con rivestimento in pelle o ecopelle_

The style is perfect, eclectic and seductive in the beauty of its contrasts. Straight lines for the seats and adjustable backs which represent the contemporary luxury in a original way. Available in the DRAPE models with fabric covering and in CAPITONNÉ with leather or eco leather_







PLAYA BUENA
informazioni tecniche
technical sheets

VERSIONE DRAPE RIVESTIMENTO
DRAPE VERSION COVERING



TV
TESSUTO VERBENA
VERBENA FABRIC

PER IL CAMPIONARIO COMPLETO
VEDI LE PAGINE FINALI
FOR THE COMPLETE SAMPLE
SEE THE FINAL PAGES

VERSIONE CAPITONNÉ RIVESTIMENTO
CAPITONNÉ VERSION COVERING



P
PELLE
LEATHER



PF
PELLE FIORE
LEGGERMENTE RITOC CATO
GRAIN LEATHER
SLIGHTLY IMPROVED



S
ECO PELLE
ECO LEATHER

FINITURE STRUTTURA
STRUCTURE FINISHING



01
BIANCO OPACO
MATT WHITE



64
ANTRACITE OPACO
MATT ANTHRACITE



72
METALLO CROMATO
CHROMED METAL

Moduli / Modules

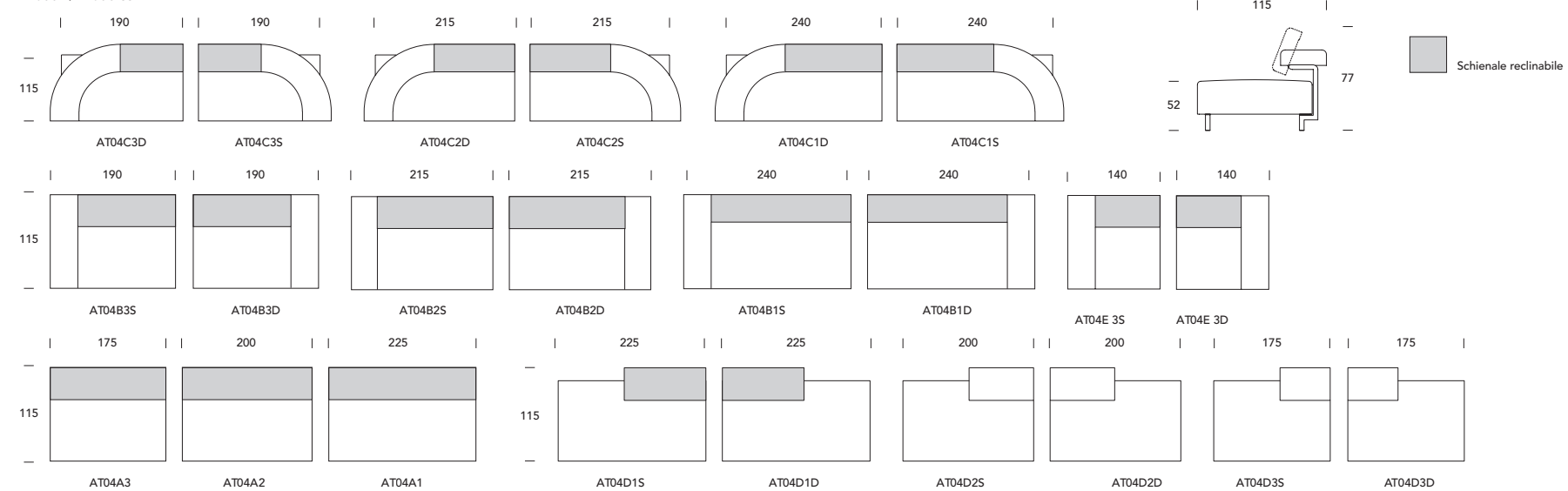

Moduli chaise longue / Chaise longue modules

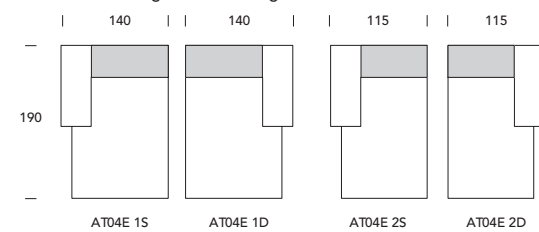

Moduli pouf / Pouf modules

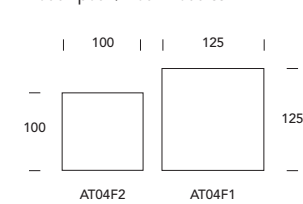

Cuscini / Cushions

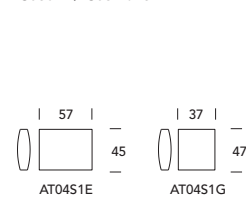

ricciolo

design_Angelo Tomaiuolo

RICCIOLO_ART. 7865

Ricciolo è la vera rivoluzione del design. Una chaiselongue che grazie ad un particolare meccanismo brevettato diventa poltrona. Un accessorio dalle forme sinuose espressione di cura per i particolari e di amore per i complementi d'arredo. Ricciolo è disponibile in diverse finiture e colorazioni_

Ricciolo is the true revolution of design: a chaise longue that becomes an armchair, thanks to a special patented mechanism. An accessory with sinuous shapes that is a true expression of care and love for details. Ricciolo is available in different finishings and colours_

Misure_Sizes

L 145 P 65 H 90





*Ricciolo ha una linea moderna ed essenziale
tipica del linguaggio del design moderno.
Dalla forma avvolgente, si trasforma
da poltrona a chaise longue,
per soddisfare le più varie esigenze di utilizzo_*

*Ricciolo has an essential and modern line which
is the main characteristic of its design. With a sleek
shape, this swivel seat turns into a chaise longue, in
order to surprise and satisfy every need_*





RICCIOLO
informazioni tecniche
technical sheets

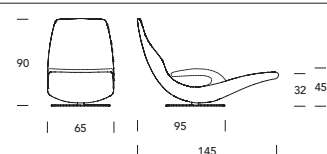

RIVESTIMENTO
COVERING



P
PELLE
LEATHER



PF
PELLE FIORE
LEGGERMENTE RITOCATO
GRAIN LEATHER
SLIGHTLY IMPROVED



S
ECO PELLE
ECO LEATHER



TO
TESSUTO ORCHIDEA
ORCHIDEA FABRIC

PER IL CAMPIONARIO COMPLETO
VEDI LE PAGINE FINALI
FOR THE COMPLETE SAMPLE
SEE THE FINAL PAGES

nolita

design_Studio 28

NOLITA_ART. AT111R

Comfort su misura, quasi sartoriale, per questa poltrona girevole rivestita in pelle con la base in metallo cromato studiata per garantire il massimo benessere agevolando la postura più corretta, mantenendo intatto un grande intuito di estetica_

Almost tailor-made comfort is offered by this swivel armchair upholstered in leather, with the base in chromed metal, designed to guarantee maximum wellbeing by facilitating the most correct posture, maintaining an attractive styling_

Misure_Sizes

L 70 P 85 H 42/118



NOLITA
informazioni tecniche
technical sheets

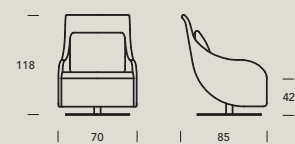

RIVESTIMENTO
COVERING



P
PELLE
LEATHER



PF
PELLE FIORE
LEGGGERMENTE RITOCOCATO
GRAIN LEATHER
SLIGHTLY IMPROVED



S
ECO PELLE
ECO LEATHER

PER IL CAMPIONARIO COMPLETO
VEDI LE PAGINE FINALI
FOR THE COMPLETE SAMPLE
SEE THE FINAL PAGES





tavolini
e pouf_
coffee
tables
and pouf

quiet
volup
splash
velo
beside
kos
ios
plissé
gomitolo

quiet

design_Nicola Tonin

QUIET_ART. 8194

Il calore del legno e l'eleganza del vetro curvi rendono Quiet estremamente originale. Una particolare tecnologia applicata a due materiali eterogenei rende questa combinazione caratterizzante.

The warmth of wood and the elegance of curved glass makes Quiet extremely original. A particular technology applied to two heterogeneous materials make this combination characterizing.

Misure_Sizes

L 106 P 106 H 33



quiet design_Nicola Tonin



QUIET
informazioni tecniche
technical sheets

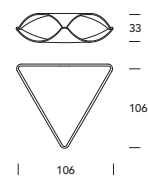

FINITURE BASE STRUCTURE FINISHING	 01 BIANCO OPACO MATT WHITE	 02 NERO OPACO MATT BLACK	 14 NOCE CANALETTO BLACK WALNUT	 59 GIALLO SENAPE OPACO MATT YELLOW MUSTARD
	FINITURA PIANO VETRO GLASS TOP FINISHING	 V81 TRASPARENTE TRANSPARENT	FINITURA PIANO VETRO SU ORDINAZIONE GLASS TOP CUSTOMIZED FINISHING	 V100 EXTRA WHITE TRASPARENTE EXTRA CLEAR TRANSPARENT

volup

design_Davide Bozzini

VOLUP_ART. 8195

Dalla sinuosità del vetro curvo nasce Volup, una scultura nata per impreziosire i salotti di ognuno di noi. L'estrema difficoltà di produzione di questo articolo lo rende unico ed inimitabile_

From the sinuosity of the curved glass comes Volup, a sculpture born to enhance the living rooms of all of us. The extreme difficulty of production of this article makes it unique and inimitable_

Misure_Sizes

L 84 P 88 H 36





VOLUP
informazioni tecniche
technical sheets

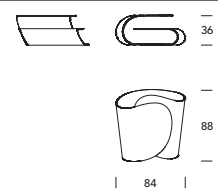

FINITURE DI SERIE
STANDARD FINISHING



V81
TRASPARENTE
TRASPARENTE

FINITURE SU
ORDINAZIONE
CUSTOMIZED
FINISHING



V85
FUMÉ TRASPARENTE
TRANSPARENT FUMÉ



V100
EXTRA WHITE TRASPARENTE
EXTRA CLEAR TRASPARENTE

splash

design_Nicola Tonin

SPLASH_ART. 8193

Tavolino con base realizzata in agglomerato di marmo e piano in vetro temperato. Splash si ispira all'acqua, ai suoi riflessi perlacei per un tocco raffinato e senza età_

Coffee table with base made in agglomerated marble and top in tempered glass. Splash is inspired from water, and its pearly reflections for a refined and ageless touch_

Misure_Sizes

Ø 100 H 33

SPLASH
informazioni tecniche
technical sheets

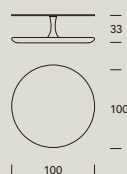

FINITURE BASE
STRUCTURE FINISHING



501
BIANCO LUCIDO
SHINING WHITE



502
NERO LUCIDO
SHINING BLACK



536
BEIGE LUCIDO
SHINING BEIGE

FINITURA PIANO VETRO
GLASS TOP FINISHING



V100
EXTRA WHITE TRASPARENTE
EXTRA CLEAR TRASPARENT



velo

design_Angelo Tomaiuolo

VELO_ART. 8166

Trasparenza assoluta, leggerezza e riflessi unici sono le caratteristiche di Velo. Tavolino in vetro curvo dalle forme morbide realizzato con tecniche speciali di curvatura del vetro_

Absolute transparency, lightness and unique reflexes are the features of Velo. Curved glass coffee table with a soft shape, manufactured with special glass bending techniques_

Misure_Sizes
L 95 P 76 H 33



VELO
informazioni tecniche
technical sheets

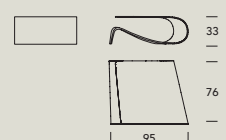

FINITURE DI SERIE
STANDARD FINISHING



V01
TRASPARENTE
TRANSPARENT

FINITURE SU
ORDINAZIONE
CUSTOMIZED
FINISHING



V05
FUMÉ TRASPARENTE
TRANSPARENT FUMÉ



V100
EXTRA WHITE TRASPARENTE
EXTRA CLEAR TRANSPARENT



beside

design_Angelo Tomaiuolo

BESIDE_ART. 8167 SX/DX

Servetto in vetro curvo ideale per chi vuole avere un comodino che diventa pratico servetto da accostare al letto o divano ed appoggiare qualsiasi oggetto o fare colazione. L'eleganza del vetro e la funzionalità dell'oggetto permette di avere un prodotto esclusivo_

Curved glass side table, perfect for those looking for night stand that turns into a practical bed side table, suitable for leaning or to have breakfast on. The elegance of the glass and the functionality of this object allows everyone to have an exclusive product_

Misure_Sizes
L 49 P 50 H 53

BESIDE

informazioni tecniche
technical sheets

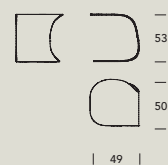

FINITURE DI SERIE
STANDARD FINISHING



VBI
TRASPARENTE
TRASPARENT

FINITURE SU
ORDINAZIONE
CUSTOMIZED
FINISHING



VBS
FUMÉ TRASPARENTE
TRANSPARENT FUMÉ



V100
EXTRA WHITE TRASPARENTE
EXTRA CLEAR TRASPARENT



kos

design_Nicola Tonin

KOS_ART. 8190/ 8190 L

Dalla tecnologia di stampaggio rotazionale del polietilene nasce il tavolino Kos. Ideale sia per esterni che per interni. Kos è design e funzionalità, infatti la semplice estrazione del top in plexiglass permette di scorgere un vano contenitore per riviste ed oggetti_

The coffee table Kos was born from the polyethylene rotational moulding technology. Perfect both for external and inside usage. Kos is a mix of design and functionality, as a matter of fact the simple extraction of the perspex top reveals an internal storage for magazines and objects_

Misure_sizes

L 112 P 95 H 33





KOS
informazioni tecniche
technical sheets

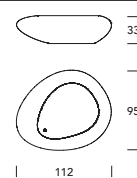

FINITURE BASE
BASE FINISHING



01
BIANCO
WHITE



36
BEIGE
BEIGE



64
GRIGIO ANTRACITE
ANTHRACITE GREY

**FINITURA BASE
CON LUCE**
BASE FINISHING
WITH LIGHT



48
BIANCO OPALINO
WHITE OPALINE

**FINITURE TOP
IN PLEXIGLASS**
PERSPEX
TOP FINISHING



X02
NERO
BLACK



X22
ROSSO RUBINO
RUBY RED



X62
BIANCO OPALINO
WHITE OPALINE



X66
FUCSIA TRASPARENTE
TRANSPARENT FUCHSIA



X81
TRASPARENTE
TRANSPARENT



X85
GRIGIO FUMÈ TRASPARENTE
TRANSPARENT GREY FUMÈ

ios

design_Nicola Tonin

SERVETTO_ART. 8191
SERVETTO CON LUCE_ART. 8191 PL
POUF_ART. 8191 PF
SERVETTO PORTABOTTIGLIE_ART. 8191 PB
SERVETTO PORTABOTTIGLIE CON LUCE_ART. 8191 BL

Dalla tecnologia dello stampaggio rotazionale del polietilene, arriva ios. Un articolo dalle “mille trasformazioni”, che da semplice servetto diventa lampada, porta bottiglie o addirittura pouf. Basta estrarre il plexiglass dalle mille colorazioni ed inserire il cuscino pouf o il piano portabottiglie per rendere l’oggetto ogni volta diverso in base alle esigenze. ios è perfetto anche per esterni_

From the polyethylene rotational moulding technology we created ios. An article of multi transformations which from simple beside table becomes lamp, bottle holder or even pouf. Just extract the perspex available in and insert the pouf cushion or the bottle holder top so that the object can be different every time depending on the needs. ios is perfect also for outdoor_

Misure_sizes
L 47 P 51 H 50
Pouf L 47 P 51 H 55





Giovane, multiuso e multicolor. Ios si trasforma ad ogni occorrenza: facile seduta con il suo soffice cuscino, pratico portabottiglie per un veloce aperitivo e per creare l'atmosfera Ios si illumina_

Young, multipurpose and multicolor. Ios changes in case of need. It is a functional pouf and a bottle holder for a quick aperitif happy hour and a perfect atmosphere_





IOS
informazioni tecniche
technical sheets

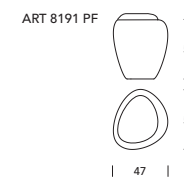
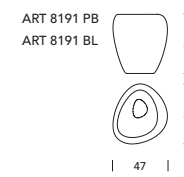
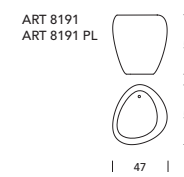

FINITURE BASE BASE FINISHING		01 BIANCO OPACO MATT WHITE		36 BEIGE OPACO MATT BEIGE		64 GRIGIO ANTRACITE OPACO MATT ANTHRACITE GREY	FINITURA BASE CON LUCE BASE FINISHING WITH LIGHT		48 BIANCO OPALINO WHITE OPALINE			
	PIANO PLEXIGLASS SERVETTO PERSPEX TOP		X02 NERO BLACK		X22 ROSSO RUBINO RUBY RED			X62 BIANCO OPALINO WHITE OPALINE		X66 FUCSIA TRASPARENTE TRANSPARENT FUCHSIA		X81 TRASPARENTE TRANSPARENT
PIANO PLEXIGLASS PORTA BOTTIGLIE TOP PERSPEX BOTTLE HOLDER		X81 TRASPARENTE TRANSPARENT		X85 GRIGIO FUMÉ TRASPARENTE TRANSPARENT GREY FUMÉ								
CUSCINO POUF OTTOMAN CUSHION		TO TESSUTO ORCHIDEA ORCHIDEA FABRIC		TN TESSUTO NINFEA NINFEA FABRIC								

plissé

design_Studio Tonin Creatives

PLISSÉ TAVOLINO_ART. 7336 P/A/G

Tavolino in ecopelle con top in vetro temperato. Realizzato artigianalmente e disponibile in svariate colorazioni e dimensioni. Plissé è perfetto per chi ama le cose raffinate ed intramontabili_

Eco-leather coffee table with tempered glass top. Handcrafted product available in varied finishings and dimensions. Plissé is perfect for those who love fine and everlasting objects_

Misure_Sizes

P Ø 69 H 30

A Ø 84 H 30

G Ø 114 H 30

PLISSÉ POUF_ART. 7335 P/A/G

Pouf in ecopelle con contenitore. Realizzato artigianalmente e disponibile in svariate colorazioni e dimensioni. Un procedimento sartoriale ad opera di mastri artigiani per il top della qualità made in Italy da adattare a tutti gli ambienti domestici_

Eco-leather Pouf with internal storage unit. Handcrafted product available in varied finishes and dimensions, this product is created using a tailoring procedure carried out by ledger artisans. The top of Made in Italy quality suitable for all home environments_

Misure_Sizes

P Ø 69 H 35

A Ø 84 H 36

G Ø 114 H 38





PLISSÈ
informazioni tecniche
technical sheets

PLISSÈ TAVOLINO_PLISSÈ COFFEE TABLES
Art. 7336 P/A/G

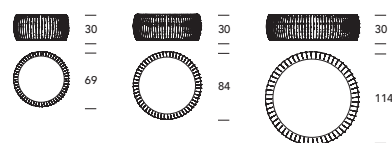

RIVESTIMENTO
COVERING



PER IL CAMPIONARIO COMPLETO
VEDI LE PAGINE FINALI
FOR THE COMPLETE SAMPLES
SEE THE FINAL PAGES

FINITURE VETRO
GLASS FINISHING

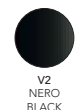

PLISSÈ POUF
Art. 7335 P/A/G

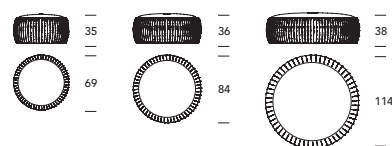

RIVESTIMENTO
COVERING



PER IL CAMPIONARIO COMPLETO
VEDI LE PAGINE FINALI
FOR THE COMPLETE SAMPLES
SEE THE FINAL PAGES

gomitolo

design_Alessandro Crosera

GOMITOLO_ART. 7338

*Un'intreccio artigianale di fili per un pouf
estremamente originale che sembra un vero gomitolo_*

*A handcrafted weaving of threads to form an extremely
original pouf which seems like a real ball of wool_*

Misure_sizes
L 53 P 53 H 50



GOMITOLO
informazioni tecniche
technical sheets



50



53

| 53 |

FINITURE BASE
STRUCTURE FINISHING



04
GIALLO OCRA
OCHRE YELLOW



21
VERDE SMERALDO
EMERALD GREEN



30
BEIGE MELANGE
BEIGE MELANGE



accessori
e complementi_
accessories
and
occasional
furniture

spiga
alga
ivy
vanilla
narciso
stone
callas

spiga

design_Angelo Tomaiuolo

SPIGA_ART. 7415_ART. 7415G

Un'ispirazione naturale per un design 100% organico. E' l'appendiabiti Spiga realizzato in polietilene ecologico con la tecnologia di stampaggio rotazionale. Disponibile nelle colorazioni più svariate ed utilizzabile anche in ambienti esterni, Spiga è un oggetto innovativo al quale non si può rinunciare_

A natural inspiration for a 100% organic design. It's the Spiga coat hanger made in ecological polyethylene using rotational moulding technology. Available in the most varied colours and useable also outdoors. Spiga is an innovative object to which one cannot renounce_

Misure_Sizes

ART. 7415 L 35 P 35 H 172

ART. 7415G L 35 P 35 H 186

SPIGA LUCE_ART. 7415L_ART. 7415LG

L'appendiabiti Spiga si arricchisce di luce diventando una raffinata lampada da terra. La doppia funzione lo rende ancora più singolare; per un prodotto che arreda senza tempo ogni luogo_

The Spiga coat hanger is enriched with light becoming a refined floor lamp. The double function makes it even more singular; for a product which furnishes timelessly any place_

Misure_Sizes

ART. 7415L L 35 P 35 H 172

ART. 7415LG L 35 P 35 H 186







SPIGA
informazioni tecniche
technical sheets

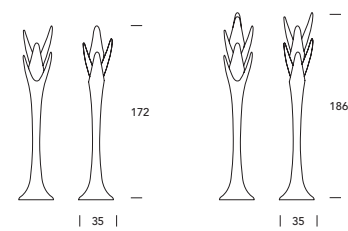

FINITURE STRUTTURA
STRUCTURE FINISHING



01
BIANCO OPACO
MATT WHITE



03
ROSSO OPACO
MATT RED



15
VERDE OPACO
MATT GREEN



36
BEIGÉ OPACO
MATT BEIGE



64
ANTRACITE OPACO
MATT ANTHRACITE GREY



66
FUCSIA OPACO
MATT FUCHSIA

**FINITURE STRUTTURA
CON LUCE**
STRUCTURE FINISHING
WITH LIGHT



48
BIANCO OPALINO
WHITE OPALINE



alga

design_Davide Bozzini

ALGA_ART. 7416

Da un'alga immersa nell'acqua nasce questo progetto decisamente "naturale". L'appendiabiti alga è realizzato in tondino di metallo curvato e laccato. Disponibile in diverse colorazioni arreda con gusto ogni ambiente_

This "natural" project derives from seaweed. The coat hanger Alga is made from a metal rod curved and lacquered. Available in different colours, it furnishes every room with taste_

Misure_Sizes

Ø 40 H 177





ALGA
informazioni tecniche
technical sheets



FINITURE
FINISHING



01
BIANCO OPACO
MATT WHITE



38
BEIGE OPACO
MATT BEIGE



59
GIALLO SENAPE OPACO
MATT YELLOW MUSTARD



64
ANTRACITE OPACO
MATT ANTHRACITE



ivy

design_Davide Bozzini

IVY_ART. 7418

Ivy è giovane e fresco, perfetto per dare colore alle pareti personalizzandole a seconda del proprio gusto. Realizzato in metacrilato bicolore, può essere posizionato senza difficoltà creando svariate combinazioni quasi come se la parete diventasse un quadro_

Ivy is young and fresh, perfect to give colours to walls, personalizing them to one's own taste. Made in two-coloured methacrylate, it may be positioned without difficulty creating various combinations almost as if the wall was a painting_

Misure_Sizes

L 14 P 8 H 18

L 12 P 7 H 14



IVY

informazioni tecniche
technical sheets



| 14 | | 8 | | 18 |



| 12 | | 7 | | 14 |

FINITURE STRUTTURA STRUCTURE FINISHING



501
BIANCO LUCIDO
SHINING WHITE



503
ROSSO LUCIDO
(RETRO BIANCO)
SHINING RED
(BACK WHITE)



515
VERDE LUCIDO
(RETRO BIANCO)
SHINING GREEN
(BACK WHITE)



vanilla

design_Alessandro Crosera

VANILLA_ART. 7339

Vanilla è un separè autoportante, imbottito e rivestito in tessuto.

E' perfetto per chi vuole avere in casa degli spazi temporaneamente appartati, senza rinunciare al design_

Vanilla is a self supporting partition, padded and upholstered in fabric.

It is perfect for those who want to have a temporary secluded space in the home without renouncing to design_

Misure_Sizes

L 120 P 4 H 174

VANILLA

informazioni tecniche
technical sheets

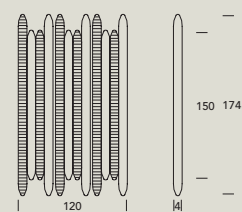

FINITURE COMBINAZIONI
POSSIBILI ASTE
FINISHING POSSIBLE
COMBINATIONS AUCTIONS



TN08
MANDORLA
ALMOND



TN29
GRIGIO GABBIANO
GREY GULL



TN04
GIALLO CEDRO
YELLOW CEDAR



TN22
TABACCO
TOBACCO



TN29
GRIGIO GABBIANO
GREY GULL



TN22
TABACCO
TOBACCO



narciso

design_Davide Bozzini

NARCISO_ART. 7490

Portaombrelli realizzato attraverso uno speciale trattamento di curvatura del metallo. Disponibile in diverse colorazioni. Narciso è nato per chi vuole avere ricercatezza nelle forme anche negli oggetti più semplici di uso quotidiano_

Umbrella-holder manufactured by a special metal bending procedure. Available in different finishings. Narciso is perfect for those who look for elegance even in the shape of the simplest daily objects_

Misure_Sizes

L 34 P 44 H 72





NARCISO
informazioni tecniche
technical sheets

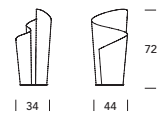

FINITURE COLORE
COLORS FINISHING



01
BIANCO OPACO
MATT WHITE



36
BEIGE OPACO
MATT BEIGE



59
GIALLO SENAPE OPACO
MATT MUSTARD YELLOW



64
ANTRACITE OPACO
MATT ANTHRACITE



66
FUCSIA OPACO
MATT FUCHSIA



stone

design_Angelo Tomaiuolo

STONE_ART. 7529 P/A/G

Stone prende forma proprio dai sassi, arricchendosi di sfumature per dare vita ad una specchiera decisamente originale_

Stone takes its concept from pebbles, enriching itself with shades, to give life to a decisively original mirror_

Misure_sizes

P L 66 P 3 H 83

A L 90 P 3 H 114

G L 121 P 3 H 152



STONE

informazioni tecniche
technical sheets

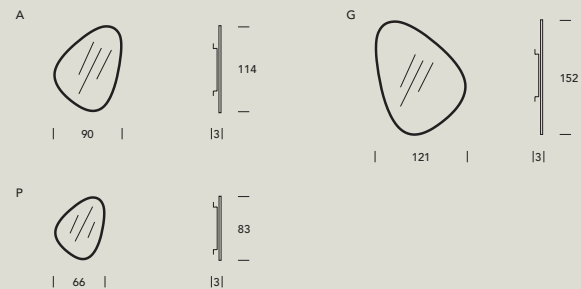

callas

design_Studio Archirivolto

CALLAS_ART.7528 Q/R

Specchiera in vetro curvo disponibile in diverse finiture e dimensioni. Callas è un oggetto di arredamento che riesce ad impreziosire ogni ambiente con estrema semplicità_

Curved glass mirror available in different finishings and dimensions. Callas is a piece of furniture that embellish every environment with extreme simplicity_

Misure_Sizes

Q L 110 P 6 H 110

R L 108 P 6 H 200

CALLAS

informazioni tecniche
technical sheets

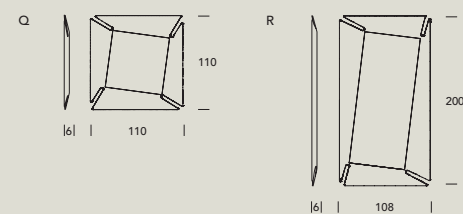

FINITURE VETRO
GLASS FINISHING



V81
TRASPARENTE
TRANSPARENT



V85
FUMÉ TRASPARENTE
TRANSPARENT FUME



letti e contenitori notte beds and night storage units

sleepy
tuny
cloud
teeny
leaves night
pacifico
venice night
île

sleepy

design_Angelo Tomaiuolo

SLEEPY_ART. 7863 M/L/XL

Letto disponibile in diverse finiture. non è il solito letto, la sua forma estremamente originale ed unica è stata pensata per le personalità più originali ed uniche. Processi di lavorazione studiati per garantire ad ogni prodotto il giusto “vestito” ed esaltare l’organicità che trasmette_

Bed available in different finishings. is not the usual bed, its extremely original form is unique and was thought for the most original and distinct personalities. Work processes studied to guarantee to every product a perfect “dress” to enhance the cohesion which transmits_

Misure_Sizes

M Materasso/mattress 160x190 L 197 P 231 H 41/90

L Materasso/mattress 160x200 L 197 P 241 H 41/90

XL Materasso/mattress 180x200 L 217 P 241 H 41/90







informazioni tecniche
technical sheets

M	— 90 —		— 41 —
		197	
		231	
L	— 90 —		— 41 —
		197	
		241	
XL	— 90 —		— 41 —
		217	
		241	

RIVESTIMENTO
COVERING



P
PELLE
LEATHER



PF
PELLE FIORE
LEGGERMENTE RITOCOCATO
GRAIN LEATHER
SLIGHTLY IMPROVED



S
ECO PELLE
ECO LEATHER

PER IL CAMPIONARIO COMPLETO
VEDI LE PAGINE FINALI
FOR THE COMPLETE SAMPLES
SEE THE FINAL PAGES



tuny

design_Alessandro Crosera

TUNY_ART. 7864 M/L/XL

TUNY_ART. 7864TR M/L/XL

TESTIERA REGOLABILE_ADJUSTABLE BEDHEAD

Letto disponibile in diverse finiture. Funzionalità estrema data dal meccanismo automatico che permette di regolare l'altezza della testiera e garantire il massimo comfort. Il connubio design e funzionalità fa dunque di Tuny un prodotto adatto ad ogni esigenza_

Bed available in different finishings. Extreme functionality given by the automatic mechanism that regulates the height of the headboard, to assure the best comfort. The mix of design and functionality makes of Tuny a product suitable for every demand_

Misure_Sizes

M Materasso/mattress 160x190 L 175 P 225 H 80

L Materasso/mattress 160x200 L 175 P 235 H 80

XL Materasso/mattress 180x200 L 195 P 235 H 80



Optional meccanismo Classic con rete e cassettoni inclusi_
Optional Classic mechanism with slats and container box included_

TUNY

informazioni tecniche
technical sheets

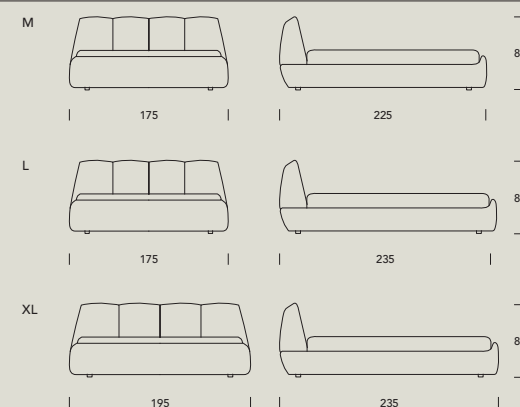

RIVESTIMENTO COVERING



PER IL CAMPIONARIO COMPLETO
VEDI LE PAGINE FINALI
FOR THE COMPLETE SAMPLES
SEE THE FINAL PAGES





cloud

design_Studio 28

CLOUD_ART. 7866 M/L/XL

Letto disponibile in diverse finiture e colorazioni per dare vitalità alla camera da letto. Inoltre la testiera reclinabile permette di avere un prodotto di estrema comodità_

Bed available in different finishings and colours to give vitality to the bedroom. In addition, the reclining headboard gives the product extreme comfort_

Misure_Sizes

M Materasso/mattress 160x190 L 183 P 223 H 92

L Materasso/mattress 160x200 L 183 P 233 H 92

XL Materasso/mattress 180x200 L 203 P 233 H 92







CLOUD
informazioni tecniche
technical sheets

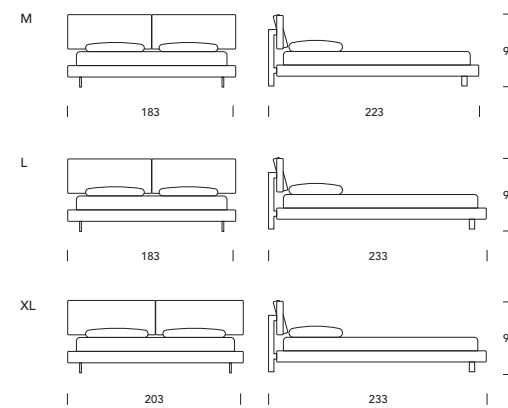

**RIVESTIMENTO
VERSIONE CAPITONNÉ
CAPITONNÉ VERSION
COVERING**

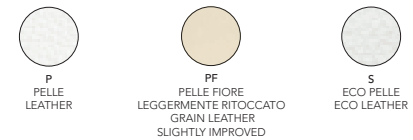

**RIVESTIMENTO
VERSIONE EASY
EASY VERSION
COVERING**

PER IL CAMPIONARIO COMPLETO VEDI LE PAGINE FINALI FOR THE COMPLETE SAMPLES SEE THE FINAL PAGES



**FINITURE STRUTTURA
STRUCTURE FINISHING**



FINITURE BORDINO PER VERSIONE EASY VEDI LISTINO PREZZI
FINISH FLANGE FOR EASY VERSION SEE PRICE LIST



teeny

design_Alessandro Crosera

TEENY_ART. 7337

Comodino disponibile in diverse finiture con top in vetro temperato.

Teeny è perfettamente abbinabile a Tuny, per non lasciare nulla al caso_

Bedside table available in different finishings with tempered glass top.

Teeny can be perfectly matched with our Tuny bed_



Misure_Sizes

L 50 P 50 H 35

TEENY

informazioni tecniche
technical sheets

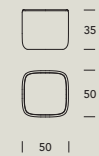

| 50 |

RIVESTIMENTO COVERING

PER IL CAMPIONARIO COMPLETO
VEDI LE PAGINE FINALI
FOR THE COMPLETE SAMPLE
SEE THE FINAL PAGES



P
PELLE
LEATHER



PF
PELLE FIORE
LEGGERMENTE RITOCOCATO
GRAIN LEATHER
SLIGHTLY IMPROVED



S
ECO PELLE
ECO LEATHER



TV
TESSUTO VERBENA
VERBENA FABRIC



TN
TESSUTO NINFEA
NINFEA FABRIC



TK
TESSUTO MIMOSA
MIMOSA FABRIC

FINITURE TOP IN VETRO GLASS TOP FINISHING

PER IL CAMPIONARIO COMPLETO
VEDI LE PAGINE FINALI
FOR THE COMPLETE SAMPLES
SEE THE FINAL PAGES



V101
EXTRA WHITE BIANCO
EXTRA CLEAR WHITE

OPTIONAL LUCE LED PER TOP VETRO OPTIONAL LED LIGHT FOR GLASS TOP

leaves night

design_Angelo Tomaiuolo

LEAVES_Programma Notte/ Night Program

Struttura in MDF e ante stampate in poliuretano tridimensionale per dare origine ad un programma notte che prende ispirazione dalle foglie.

Il massimo della qualità e del design_

Structure in mdf and three dimensional doors moulded in polyurethane to give origin to a night collection which takes inspiration from leaves.

The maximum of quality and design_

Misure_Sizes

ART. 8544 L 160 P 51 H 63

ART. 8545 L 120 P 51 H 63

ART. 8546 L 41 P 43 H 43

ART. 8547 L 81 P 43 H 116

ART. 8548 L 120 P 51 H 81





LEAVES

informazioni tecniche
technical sheets

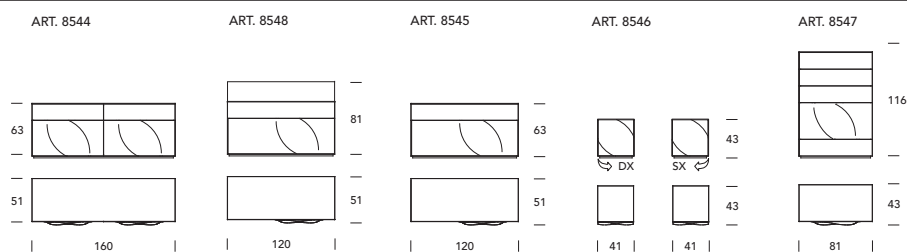

FINITURE STRUTTURA
E CASSETTI IN TINTA
STRUCTURE AND
DRAWERS FINISHING

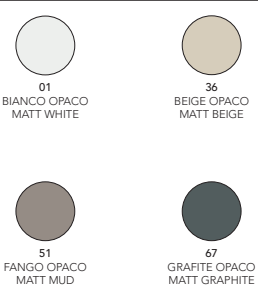

OPTIONAL IL TOP IN VETRO IN TINTA CON LA STRUTTURA
OPTIONAL GLASS TOP TO MATCH THE STRUCTURE

pacifico

design_Studio 28

PACIFICO_ART. 7862 M/L/XL

Letto di grande impatto scenografico che rimane un vero must della notte.

Completamente rifinito con lavorazione capitonné Pacifico è assoluta classe ed eleganza_

Bed of great scenographic impact which is a real must for the night area.

Completely finished with capitonné manufacturing, Pacifico is absolute class and elegance_

Misure_Sizes

M Materasso/mattress 160x190 L 173 P 205 H 147

L Materasso/mattress 160x200 L 173 P 215 H 147

XL Materasso/mattress 180x200 L 193 P 215 H 147

PACIFICO informazioni tecniche technical sheets

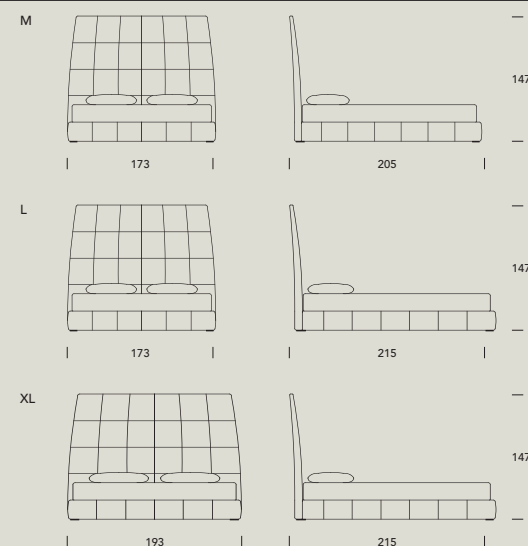

RIVESTIMENTO COVERING

PER IL CAMPIONARIO COMPLETO
VEDI LE PAGINE FINALI
FOR THE COMPLETE SAMPLE
SEE THE FINAL PAGES



P
PELLE
LEATHER



PF
PELLE FIORE
LEGGGERMENTE RITOCATO
GRAIN LEATHER
SLIGHTLY IMPROVED



S
ECO PELLE
ECO LEATHER

OPTIONAL MECCANISMO PRATIK
E MECCANISMO CLASSIC CON RETE
E CASSETTONI INCLUSI
OPTIONAL MECHANISM CLASSIC
AND PRATIK WITH SLATS AND
CONTAINER BOX INCLUDED





venice night

design_Studio 28

VENICE _Programma Notte/ Night Program

Struttura in MDF, microgoffrato lavorato a laser per ottenere un effetto capitonné decisamente morbido. Un programma raffinato, curato in ogni minimo dettaglio a partire dal top in vetro temperato verniciato in tinta con la struttura_

Structure in micro embossed MDF worked with laser in order to get a tufted effect definitely soft. A refined program prepared designed paying attention to the smallest details starting from the tempered glass top laquered in the same colour as the structure_

Misure_Sizes

ART. 8255 L 57 P 56 H 111

ART. 8256 L 57 P 56 H 39

ART. 8260 L 216 P 56 H 57

ART. 8261 L 105 P 3 H 105

ART. 8263 L 114 P 56 H 57



VENICE NIGHT

informazioni tecniche
technical sheets

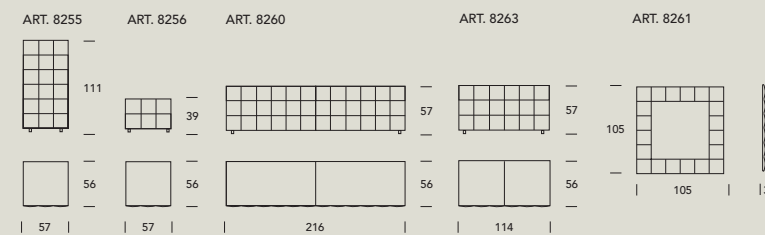

FINITURE STRUTTURA STRUCTURAL FINISHING



DI SERIE TOP IN VETRO EXTRACHIARO IN TINTA CON STRUTTURA.
STANDARD TOP IN EXTRA CLEAR GLASS SAME COLOUR AS STRUCTURE.

île

design_Studio 28

ÎLE_ART. 7860 M/L/XL

Combinano innovazione e tradizione i letti più recenti e Île né è uno splendido esempio con una grande riconferma: la pelle impreziosita da una delicata lavorazione capitonné. La testiera ellittica reinterpreta in chiave moderna un classico della notte_

The latest beds combine innovation and tradition, and Île is a wonderful example with a reconfirmation: the leather enhanced by a delicate capitonné manufacturing. The elliptical headboard reinterprets a classic bedroom in a modern key_

Misure_Sizes

M Materasso/mattress 160x190 L 229 P 218 H 84

L Materasso/mattress 160x200 L 229 P 228 H 84

XL Materasso/mattress 180x200 L 249 P 228 H 84



ÎLE

informazioni tecniche
technical sheets

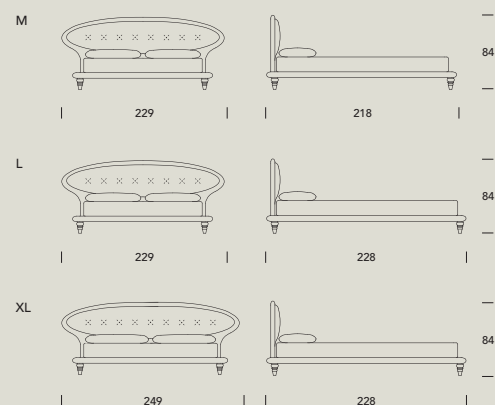

RIVESTIMENTO
COVERING



P
PELLE
LEATHER



PF
PELLE FIORE
LEGGERMENTE RITOCATO
GRAIN LEATHER
SLIGHTLY IMPROVED



S
ECO PELLE
ECO LEATHER

PER IL CAMPIONARIO COMPLETO
VEDI LE PAGINE FINALI
FOR THE COMPLETE SAMPLE
SEE THE FINAL PAGES

campionario – sample collection

FINITURE E COLORI FINISHING AND COLORS

V - VETRI GLASSES

P - PELLE LEATHER

PF - PELLE FIORE LEGGERMENTE RITOCATO GRAIN LEATHER SLIGHTLY IMPROVED

S - ECO PELLE ECO LEATHER

TV - TESSUTO VERBENA VERBENA FABRIC

--	--	--	--	--	--	--	--

TN - TESSUTO NINFEA NINFEA FABRIC

--	--	--	--	--	--	--	--

TO - TESSUTO ORCHIDEA ORCHIDEA FABRIC

--	--	--	--	--	--	--	--

X - PLEXIGLASS PERSPEX

--	--	--	--	--	--

TK - TESSUTO MIMOSA MIMOSA FABRIC

--	--	--	--	--	--

K - CUOIO LEATHER

La ditta TONIN CASA S.R.L. si riserva la facoltà di modificare in qualunque momento e senza preavviso, le caratteristiche tecniche degli elementi usati nel presente catalogo. Alcuni accessori presenti nelle immagini fotografiche non sono prodotti dalla ditta TONIN CASA S.R.L. Si prega di far riferimento al listino prezzi. La ditta TONIN CASA S.R.L. si riserva inoltre il diritto di apportare ai propri prodotti quelle modifiche che si riterranno necessarie o utili al fine di migliorarli senza pregiudicarne le caratteristiche essenziali. È vietata ogni riproduzione totale e parziale in Italia e all'estero.

TONIN CASA S.R.L. reserves the right to modify the technical characteristics of the elements used in the present catalogue at any time and without warning. Some accessories present in the photographs are not produced by TONIN CASA S.R.L. Please refer to price list. TONIN CASA S.R.L. also reserves the right to carry out modifications which it considers necessary or useful in order to improve its products, without prejudicing the essential characteristics. Total or partial reproduction prohibited in Italy or any other country.

www.tonincasa.it

A.D. e grafica: Adriani & Rossi Edizioni

Photo: Studio Indoor - Oderzo (TV)

Fotolito: Zincografia Verona

Stampa: Grafiche Antiga Spa

Stampato in Italia Giugno 2012